

RISH Relay - V / Hz

Line Monitoring Relay

Technical Datasheet



True RMS Digital Protection Relay

RISH Relay V/Hz is used to protect against Over Voltage, Under Voltage, Phase Unbalance, Phase Sequence detection, Phase Failure detection, Under and Over Frequency conditions.

- ▼ True RMS Measurement
- ▼ Trip relay cum DPM with Class 0.5
- ▼ 4 digit 7 segment LED display
- ▼ 7 different parameters on site selection
- ▼ Stores last 15 faults
- ▼ Configuration via USB-based PRKAB
- ▼ Dual color LED for fault indication
- ▼ Detection of fault with display of parameter value



RISHABH
INSTRUMENTS
Measure, Control & Record with a Difference

RISHABH INSTRUMENTS PVT.LTD.
F-31, MIDC, Satpur, Nashik-422 007, India.
Tel.: +91 253 2202160, 2202202 Fax : +91 253 2351064
E-mail : India :- marketing@rishabh.co.in
International :- exp.marketing@rishabh.co.in
www.rishabh.co.in

RISH *Relay* - V / Hz

Line Monitoring Relay



Applications:

- ▶ Over voltage
- ▶ Under voltage
- ▶ Start up standby generators
- ▶ Operation of mains failure units
- ▶ Switching standby hybrid supplies
- ▶ Protecting computer supplies
- ▶ Close control of equipment
- ▶ Gensets - to monitor correct operation of the AVR (Automatic voltage regulator) and excitation system
- ▶ Motors-Some electric motors are voltage sensitive, and can overheat and burn out when operated at low voltage
- ▶ UPS supplies - When the main A. C. supply falls outside the acceptable operating voltage window the relay can initiate a change over to an alternate or standby supply
- ▶ Motors - Single Phasing
- ▶ Incorrect sequence connection.

Product Features:

- ▶ **Over voltage protection**
- ▶ **Under voltage protection**
- ▶ **Single phasing protection**
- ▶ **Phase unbalance protection**
- ▶ **Phase incorrect sequence protection**
- ▶ **Over frequency protection**
- ▶ **Under frequency protection**
- ▶ **4 Digits ultra bright 7 Segment LED Display**
- ▶ **Trip Relay cum DPM with Class 0.5**
- ▶ **True RMS measurement**
The instrument measures distorted waveform up to 15th harmonic.
- ▶ **Previous fault Storage**
Instrument memorizes the last 15 fault occurred.
- ▶ **LED Indication**
 - LED indication for relay-1 and relay-2 status .
 - Trip indication are displayed on 4 Digit display.
 - Dual color LED for per phase indication green color for normal condition and Red color for faulty condition.
- ▶ **User selectable 3 phase 3W or 4W**
User can on site program the network connection as either 1P2W / 3P4W / 3P3W network using front panel keys.
- ▶ **User selectable System Sequence**
User can program System Phase sequence as 123 or 321.
- ▶ **Adjustable set point for**
 - Over voltage.
 - Under voltage.
 - Phase failure.
 - Phase Unbalance.
 - Over frequency.
 - Under frequency.
- ▶ **Adjustable time delay for**
 - Over voltage.
 - Under voltage.
 - Phase failure.
 - Phase Unbalance.
 - Over frequency.
 - Under frequency.
- ▶ **AND function**
User can use ANDing function to set trip on any two fault condition.
- ▶ **Configuration via USB-based PRKAB**
User can configure the Meter using USB-based PRKAB.
- ▶ **Trip or Buzzer mode**
Relay can be used to protect the system or simply to control the buzzer. Trip mode is for protection purpose and Buzz mode is for buzzer control.



RISHABH
INSTRUMENTS

Measure, Control & Record with a Difference

RISHABH
INSTRUMENTS

RISHABH INSTRUMENTS PVT.LTD.
F-31, MIDC, Satpur, Nashik-422 007, India.
Tel.: +91 253 2202160, 2202202 Fax : +91 253 2351064
E-mail : India :- marketing@rishabh.co.in
International :- exp.marketing@rishabh.co.in
www.rishabh.co.in

RISH *Relay* - V / Hz

Line Monitoring Relay

▶ Auto / Manual reset

In auto mode instrument automatically clears itself. If the device set into manual mode, the device must be manually reset by push button through display if it goes into fault.

▶ User selectable PT primary

The Primary of Potential transformer can be programmed on site from 100 VL-L to 1200 kVL-L for Voltage trip relay.

▶ User selectable PT Secondary

The input rated voltage can be programmed on site as 100 - 600VL-L using front panel keys.

▶ **Onsite selection of Auto scroll / Fixed Screen**
User can set the display in auto scrolling mode or fixed screen mode using front panel keys.

▶ **Compliance to International Safety standards**
Compliance to International Safety standard IEC 61010-1- 2010.

▶ **EMC Compatibility**
Compliance to International standard IEC 61326 - 1.

Dimensions Details:

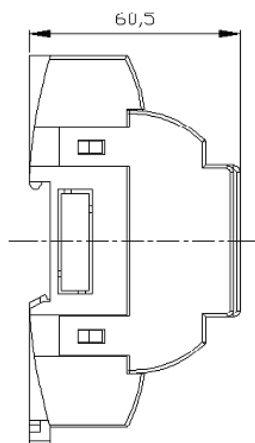
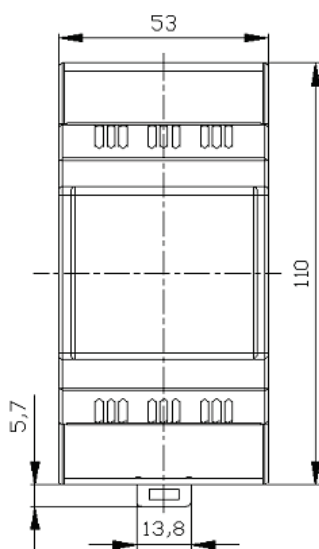

Technical Specifications:

Input Voltage

Nominal Input Voltage (AC RMS)	600VL-L (346.42VL-N)
Max Continuous Input Voltage	127% of PT Secondary
System PT Secondary Values	100VL-L to 600 VL-L programmable on site
System PT Primary Values	100VL-L to 1200 kVL-L programmable on site
Nominal Frequency	50 / 60 Hz (programmable on site)
Input Voltage Burden	< 0.6VA approx.

Auxiliary Supply

External Higher Aux	60 V – 300 V AC/DC
Higher Aux Nominal value	230 V AC/DC 50/60 Hz for AC Aux
OR	
External Lower Aux	20 V – 60 VDC / 20 V – 40 VAC
Lower Aux Nominal value	48 VDC / 24 VAC 50/60 Hz for AC Aux
Aux Supply Frequency	45 to 66 Hz range
Aux Supply Burden	< 4VA approx.

Overload Withstand

Voltage	2 x rated value for 1 second, repeated 10 times at 10 seconds
---------	---

Operating Measuring Ranges

Voltage Range	20...125% of PT Secondary
Frequency	40...70Hz

Reference condition for Accuracy

Reference Condition	23°C +/- 2°C
Input waveform	Sinusoidal (distortion factor 0.005)
Input Frequency	50 or 60 Hz ±2%
Auxiliary supply voltage	Nominal Value ±1%
Auxiliary supply frequency	Nominal Value ±1%



RISHABH INSTRUMENTS
Measure, Control & Record with a Difference

RISHABH INSTRUMENTS PVT.LTD.
F-31, MIDC, Satpur, Nashik-422 007, India.
Tel.: +91 253 2202160, 2202202 Fax : +91 253 2351064
E-mail : India :- marketing@rishabh.co.in
International :- exp.marketing@rishabh.co.in
www.rishabh.co.in

RISH *Relay* - V / Hz

Line Monitoring Relay

Electrical Connection:

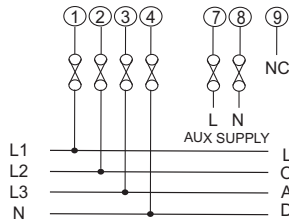

3 Phase 4 wire Unbalanced load

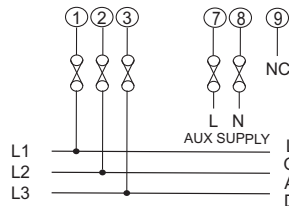

3 Phase 3 wire Unbalanced load

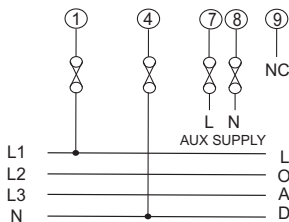

1 Phase 2 Wire

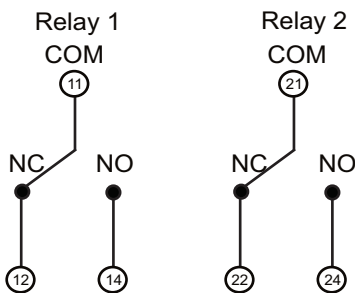

Note- Relay Contacts are shown in power off condition

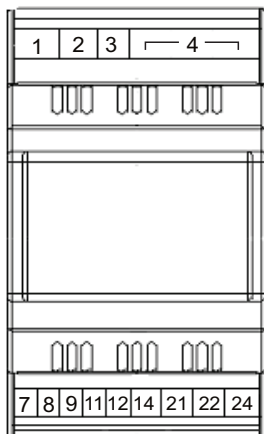

Technical Specifications:

Accuracy

Voltage	±0.5% of nominal value
Frequency	±0.2 Hz
Power ON, Trip, Reset Delays	±140 msec or ±5% of Set Delay, Whichever is Greater (WIG)

Influence of Variations

Temperature coefficient :	0.025%/°C for Voltage
---------------------------	-----------------------

Applicable Standards

EMC	IEC 61326-1:2012, Table 2
Immunity Low level	IEC 61000-4-3. 10V/m min – Level 3 industrial
Safety	IEC 61010-1-2010 , Permanently connected use
IP for water & dust	IEC60529
Pollution degree:	2
Installation category:	300V CAT III / 600V CAT II
High Voltage Test	2.2 kV AC, 50Hz for 1 minute between all Electrical circuits.

Environmental

Operating temperature	-10 to +55°C
Storage temperature	-25 to +70°C
Relative humidity	0... 90% non condensing
Shock	15g in 3 planes
Vibration	10... 55 Hz, 0.15mm amplitude
Enclosure	IP20 (front face only)

Relay Contacts

Types of output	1CO, 2CO, 1CO+1CO
Contact Ratings (Res. Load)	5A/250VAC/30VDC
Mechanical Endurance	1x10 ⁷ OPS
Electrical Endurance	NO- 3x10 ⁴ OPS NC- 1x10 ⁴ OPS 1x10 ⁵ OPS
	for 1CO / 1CO+1CO relay for 2CO relay

Mechanical Attributes

Weight	300g Approx.
--------	--------------



RISHABH INSTRUMENTS
Measure, Control & Record with a Difference

RISHABH INSTRUMENTS PVT.LTD.
F-31, MIDC, Satpur, Nashik-422 007, India.
Tel.: +91 253 2202160, 2202202 Fax : +91 253 2351064
E-mail : India :- marketing@rishabh.co.in
International :- exp.marketing@rishabh.co.in
www.rishabh.co.in

RISH Relay - V / Hz

Line Monitoring Relay

Characteristics:

Over (OV) and Under (UV) voltage

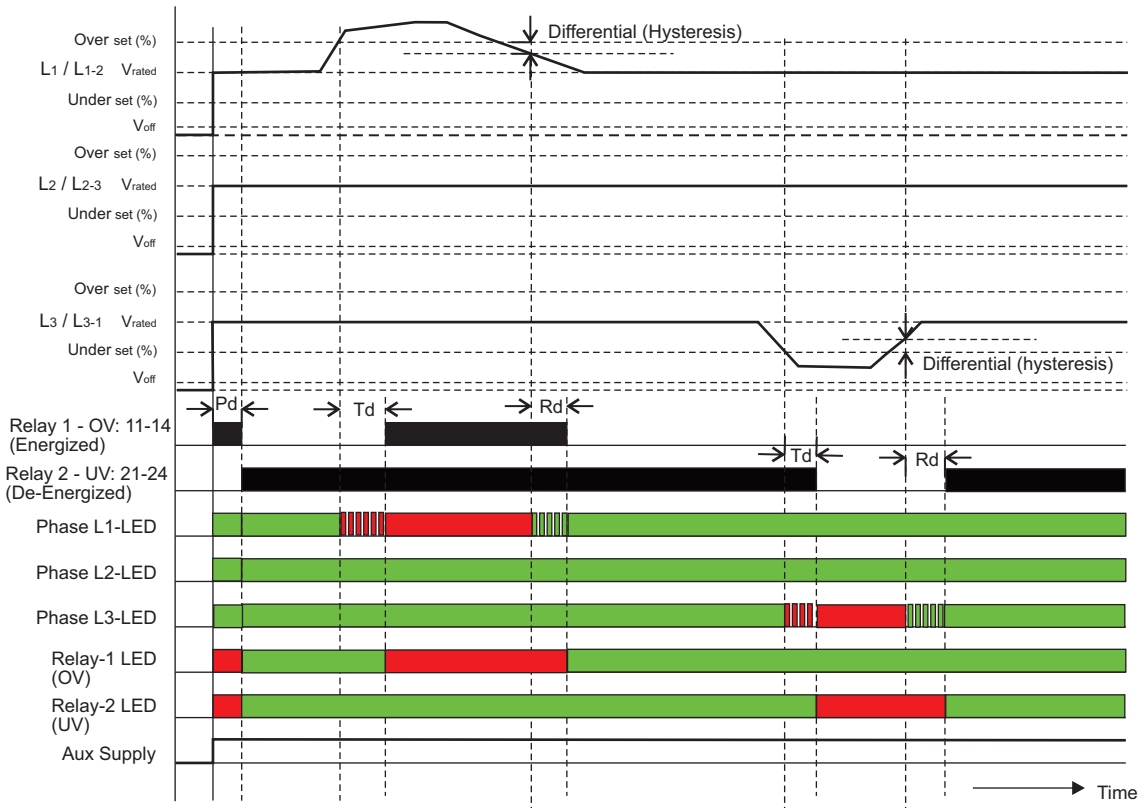

Relay States -

- Energized
- De-Energized

Phase Failure (Ph.F) and Phase Unbalance (Ph.un)

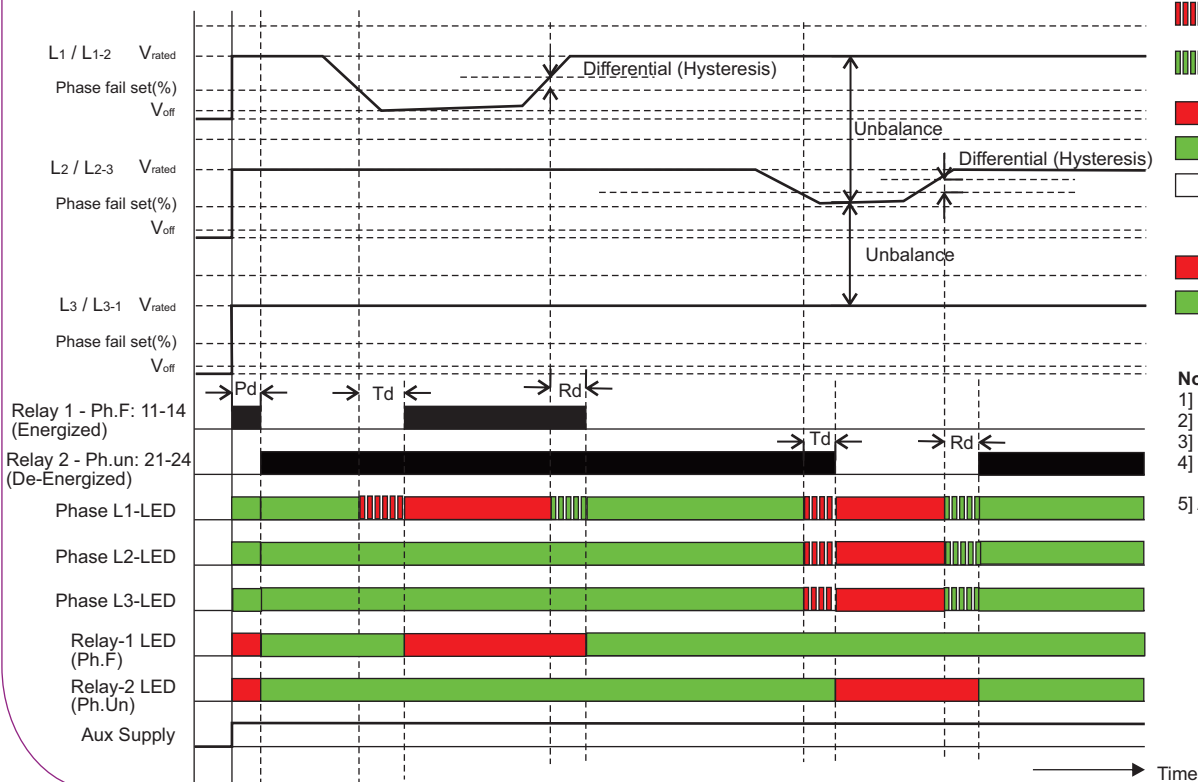

Phase LED Indications -

- Red blinking - Trip Delay (only Phase LEDs)
- Green blinking - Reset Delay (only Phase LEDs)
- RED ON - fault condition
- Green ON - healthy condition
- Input Absent

Relay LED Indications -

- RED ON - fault condition
- Green ON - healthy condition

Note:

- 1] Pd- Power ON delay
- 2] Td- Trip delay
- 3] Rd- Reset delay
- 4] Both relay can be configured to energize or de-energize mode
- 5] Any relay can be assigned to any fault condition



RISHABH INSTRUMENTS
Measure, Control & Record with a Difference

RISHABH INSTRUMENTS PVT.LTD.
F-31, MIDC, Satpur, Nashik-422 007, India.
Tel.: +91 253 2202160, 2202202 Fax : +91 253 2351064
E-mail : India :- marketing@rishabh.co.in
International :- exp.marketing@rishabh.co.in
www.rishabh.co.in

RISH Relay - V / Hz

Line Monitoring Relay

Over (OF) and Under (UF) Frequency

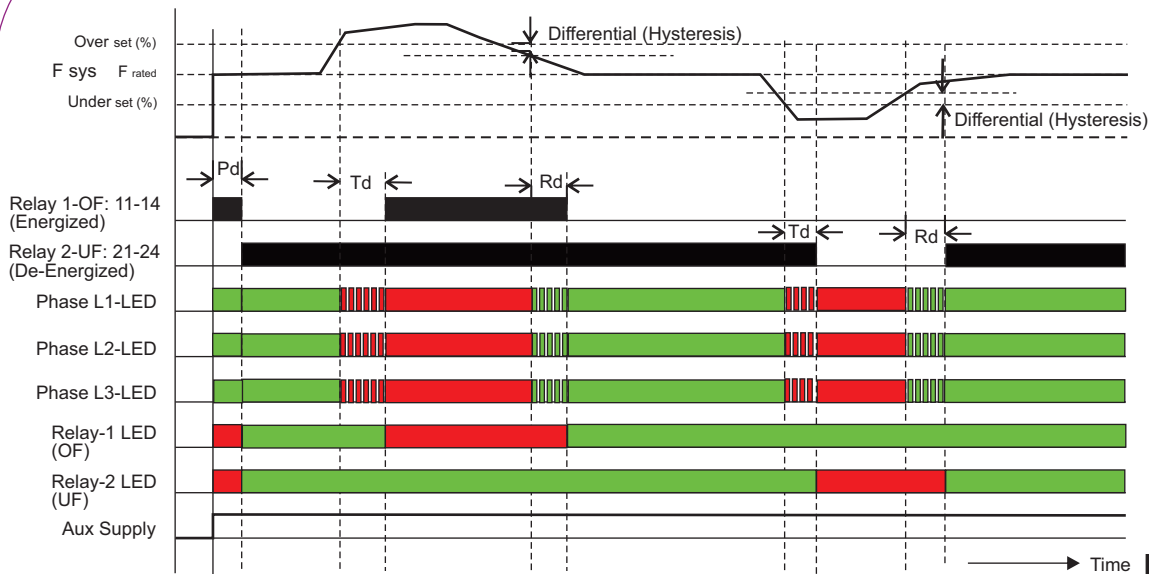

Relay States -

■ Energized
□ De-Energized

Phase LED Indications -

▤ Red blinking - Trip Delay (only Phase LEDs)
▤ Green blinking - Reset Delay (only Phase LEDs)
■ RED ON - fault condition
■ Green ON - healthy condition
□ Input Absent

Relay LED Indications -

■ RED ON - fault condition
■ Green ON - healthy condition

Note:

- 1) Pd- Power ON delay
- 2) Td- Trip delay
- 3) Rd- Reset delay
- 4) Both relay can be configured to energize or de-energize mode
- 5) Any relay can be assigned to any fault condition

Phase sequence (Ph.r)

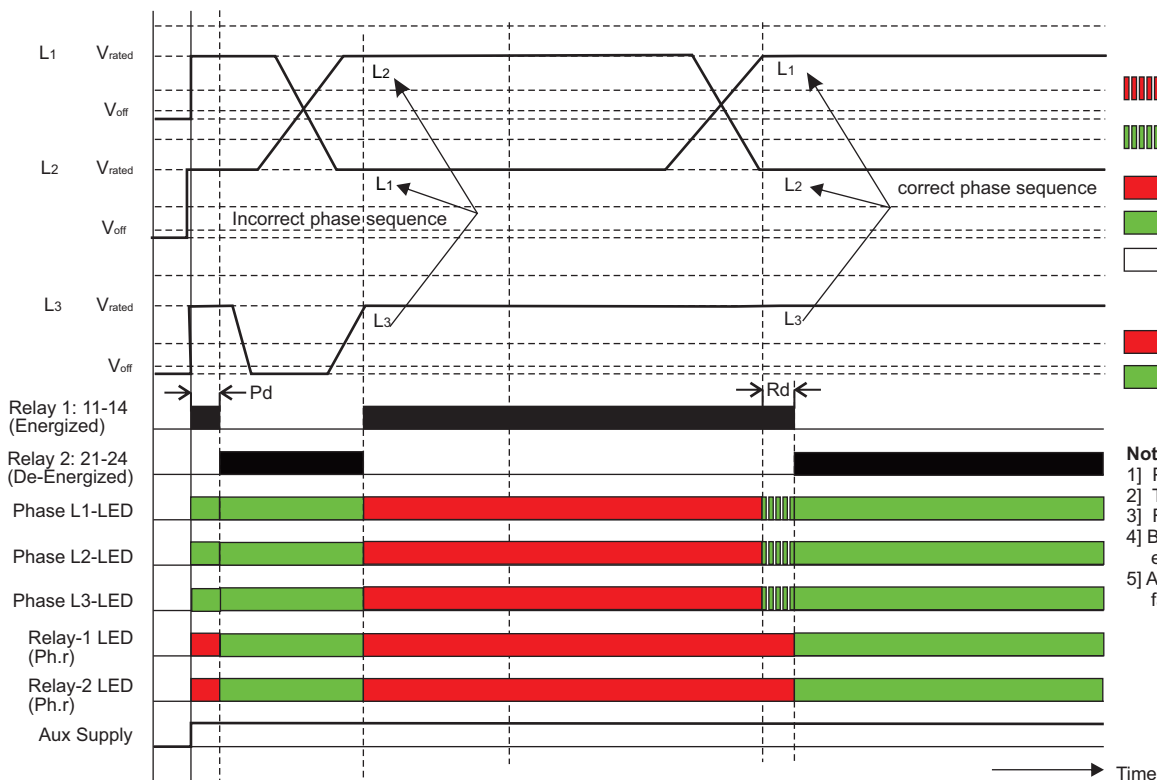

ANSI Numbers:

ANSI Number	Acronyms
27	Under Voltage Relay
47	Phase-Sequence or Phase-Unbalance Voltage Relay
59	Over Voltage Relay
81	Over / Under Frequency Relay



RISHABH INSTRUMENTS
Measure, Control & Record with a Difference

RISHABH INSTRUMENTS PVT.LTD.
F-31, MIDC, Satpur, Nashik-422 007, India.
Tel.: +91 253 2202160, 2202202 Fax : +91 253 2351064
E-mail : India :- marketing@rishabh.co.in
International :- exp.marketing@rishabh.co.in
www.rishabh.co.in

RISH Relay - V / Hz

Line Monitoring Relay

Operating elements:

- 1 - L1- LED : Indicates status of V1 (in 3P4W) and V1-2 in 3P3W. It Lights green when input voltage is healthy, red in fault condition, red blinking in trip delay and green blinking in reset delay.
- 2 - L2-LED : Indicates status of V2 (in 3P4W) and V2-3 in 3P3W. It Lights green when input voltage is healthy, red in fault condition, red blinking in trip delay and green blinking in reset delay.
- 3 - L3- LED : Indicates status of V3 (in 3P4W) and V3-1 in 3P3W. It Lights green when input voltage is healthy, red in fault condition, red blinking in trip delay and green blinking in reset delay.
- 4/5 - Relay-1 and Relay-2 status LED : Indicates status of relay-1 and relay-2 respectively. It lights green for relay in healthy condition and red for relay in trip condition.
- 6 - 4 Digit ultra bright 7 seg LED Display.
- 7 - K LED : It is used to show value in KV.
- 8 - Enter Key : Confirms changes of parameter setting. When on the measurement screen, holding for 3 sec enters in setup menu.
- 9- Test Key : Increments setting value, move upwards in the menu or change parameter. It is also used to test operation of relay. Continuous holding of test key changes relay position and when released, it resets the relay position (Only in healthy condition).
- 10- Reset Key : Decrements setting value, move downwards in the menu or change parameter. It is also used to reset relay when manual reset mode is selected.
- 11- Configuration via USB-based PRKAB.

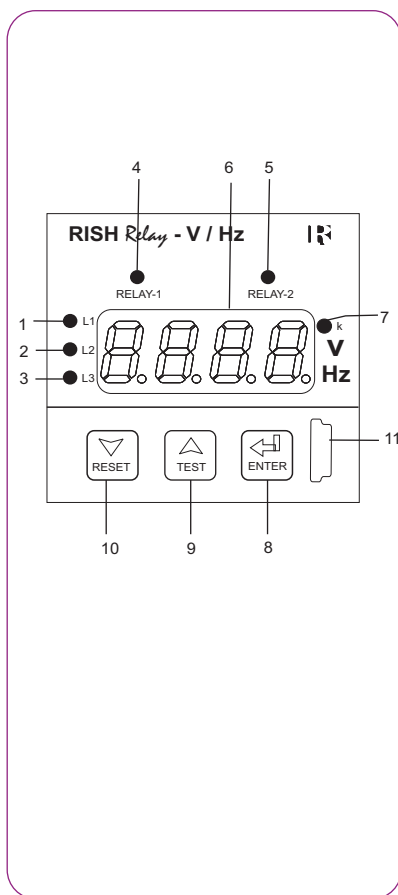

Parameter Settings :

Parameters	RISH Relay-V/Hz
Trip setting for phase failure	20 - 85%
Trip setting for Voltage Unbalance	2 - 20%
Trip setting for over voltage	101 - 125%
Trip setting for under voltage	70 - 99%
Trip setting for Max Frequency	101 - 110%
Trip setting for Min Frequency	90 - 99%
Setting for Differential / hysteresis	1 - 15%*
Nominal Frequency settable	50 / 60 Hz
Individual Faults can be deactivated as per system requirement	Yes (Phase failure can not be deactivated)
Reset option	Auto / Manual
Relay control mode	De-energize/energize
Reset Delay	0.2 - 30s
Programmable trip Delay for over voltage, Under Voltage, Over Frequency, Under Frequency, Phase failure, Phase Unbalance	0 - 30s
PT primary Voltage(V L-L)	100 - 1200KV L-L
Power ON Delay	0.5 - 30s

NOTE : Regenerate voltage may get produced in open phase due to blown fuse for some loads. In such a case, set the trip point for Phase Failure (20 - 85%) as per requirement considering the possibility of a higher regenerated voltage

* Differential setting range for voltage unbalance is limited as per its setting of trip point.



RISHABH INSTRUMENTS PVT.LTD.
F-31, MIDC, Satpur, Nashik-422 007, India.
Tel.: +91 253 2202160, 2202202 Fax : +91 253 2351064
E-mail : India :- marketing@rishabh.co.in
International :- exp.marketing@rishabh.co.in
www.rishabh.co.in

RISH *Relay* - V / Hz

Line Monitoring Relay

Hysteresis Calculation Method:

Example: -

For "OV" (Over Voltage)

PT Secondary = 100 V_{L-L}

Trip point = 105% of PT Secondary = 105 V_{L-L}

Hysteresis = 2% of PT Secondary = 2 V_{L-L}

Relay Reset point = Trip point - Hysteresis

= 105 - 2

= 103 V_{L-L}

Example: -

For "Ph.un" (Phase Unbalance)

PT Secondary = 100 V_{L-L}

Trip point = 10% of PT Secondary = 10 V_{L-L}

Hysteresis = 2% of PT Secondary = 2 V_{L-L}

Relay Reset point = Trip point - Hysteresis

= 10 - 2

= 8 V_{L-L}

Ordering Information:

Ordering information	Ordering Code RISH <i>Relay</i> - V/Hz
System Type	
Single Phase	1
Three Phase (On-site programmable to 1P2W / 3P4W / 3P3W)	3
Relay type of outputs	
1CO+1CO	1001
1CO	1000
2CO	1002
Auxiliary Supply Voltage	
60 - 300 V AC/DC	HA
20 - 60 VDC / 20 - 40 VAC	LA

Order Code Example:

1. RISH Relay V/Hz - 1 - 1001 - HA:

RISH Line Monitoring Relay, Single Phase, Relay contact 1CO+1CO, External Aux 60-300 V AC/DC.

2. RISH Relay V/Hz - 3 - 1002 - LA:

RISH Line Monitoring Relay, Three Phase, Relay contact 2CO, External Aux 20-60 VDC / 20-40 VAC.



RISHABH
INSTRUMENTS
Measure, Control & Record with a Difference

RISHABH INSTRUMENTS PVT.LTD.
F-31, MIDC, Satpur, Nashik-422 007, India.
Tel.: +91 253 2202160, 2202202 Fax : +91 253 2351064
E-mail : India :- marketing@rishabh.co.in
International :- exp.marketing@rishabh.co.in
www.rishabh.co.in