

MGA-30216

1.7-2.7GHz
½ Watt High Linearity Amplifier



Data Sheet

Description

Avago Technologies' MGA-30216 is a high linearity ½ Watt PA with good OIP3 performance and exceptionally good PAE at p1dB gain compression point, achieved through the use of Avago Technologies' proprietary 0.25um GaAs Enhancement-mode pHEMT process.

The device required simple matching components to achieve wide bandwidth performance since it has a built in input prematch.

The adjustable temperature compensated internal bias circuit allowed the device to be operated at either class A or class AB operation

The MGA-30216 is housed inside a standard 16 pin QFN 3X3 package.

Applications

- Class A driver amplifier for GSM/PCS/W-CDMA/WiMAX Base Stations.
- General purpose gain block.

Component Image

16 pin QFN 3X3 package

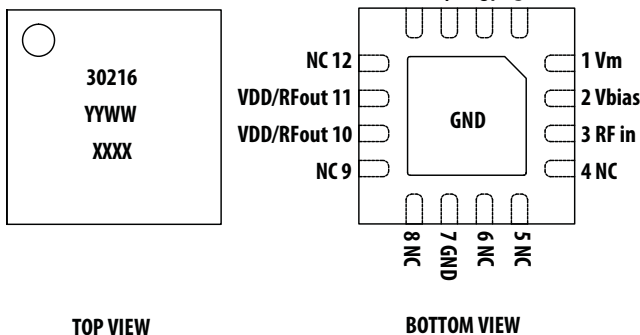

Notes:
Package marking provides orientation and identification
"30216" = Device Part Number
"YYWW" = Year and Work Week of manufacture
"XXXX" = Last 4 digit of Lot number

Features

- High linearity and P1dB
- Unconditionally Stable across load condition
- Built in adjustable temperature compensated internal bias circuitry
- With prematch - required simple matching
- GaAs E-pHEMT Technology [1]
- Standard QFN 3X3 package
- 5V supply
- Excellent uniformity in product specifications
- Tape-and-Reel packaging option available
- MSL-1 and Lead-free
- High MTTF for base station application

Specifications

2GHz; 5V, 206mA (typ)

- 14.2 dB Gain
- 45.3 dBm Output IP3
- 29 dBm Output Power at 1dB gain compression
- 48.9% PAE at P1dB
- 2.8 dB Noise Figure

Notes:

1. Enhancement mode technology employs positive gate voltage, thereby eliminating the need of negative gate voltage associated with conventional depletion mode devices.



Attention: Observe precautions for handling electrostatic sensitive devices.

ESD Machine Model = 60 V
ESD Human Body Model = 300 V
Refer to Avago Application Note A004R:
Electrostatic Discharge, Damage and Control.

Absolute Maximum Rating^[1] T_A=25°C

Symbol	Parameter	Units	Absolute Max.
V _{dd,max}	Device Voltage, RF output to ground	V	5.5
I _{ds,max}	Device Drain Current	mA	400
V _{ctrl,max}	Control Voltage	V	5.5
P _{in,max}	CW RF Input Power	dBm	22
P _{diss}	Total Power Dissipation ^[2]	W	2.2
T _{j,max}	Junction Temperature	°C	150
T _{STG}	Storage Temperature	°C	-65 to 150

Thermal Resistance^[3] $\theta_{jc} = 36^{\circ}\text{C}/\text{W}$ (V_{dd}=5, I_{ds}=200mA, T_c=85°C)

Notes:

1. Operation of this device in excess of any of these limits may cause permanent damage.
2. This is limited by maximum V_{dd} and I_{ds}. Derate 28mW/°C for T_c>70.8°C.
3. Thermal resistance measured using Infra-Red measurement technique.

Electrical Specifications^[4]

T_A = 25 °C, V_{dd} = 5V, V_{ctrl} = 5V, RF performance at 2.0 GHz, measured on demo board (see Fig. 7) unless otherwise specified.

Symbol	Parameter and Test Condition	Units	Min.	Typ.	Max.
I _{ds}	Quiescent current	mA	155	206	255
I _{ctrl}	V _{ctrl} current	mA	-	7	-
Gain	Gain	dB	13	14.0	16
OIP3 ^[5]	Output Third Order Intercept Point	dBm	41	45.3	-
OP1dB	Output Power at 1dB Gain Compression	dBm	27	29	-
PAE	Power Added Efficiency	%	-	48.9	-
NF	Noise Figure	dB	-	2.8	-
S11	Input Return Loss, 50Ω source	dB	-	-18	-
S22	Output Return Loss, 50Ω load	dB	-	-22	-
S12	Reverse Isolation	dB	-	-21	-

Notes:

4. Measurements at 2.0GHz obtained using demo board described in Figure 6 and 7.
5. 2.0GHz OIP3 test condition: F_{RF1} - F_{RF2} = 10MHz with input power of -5dBm per tone measured at worse side band
6. Use proper bias, heat sink and de-rating to ensure maximum channel temperature is not exceeded. See absolute maximum ratings and application note (if applicable) for more details.

Product Consistency Distribution Charts^[1, 2]

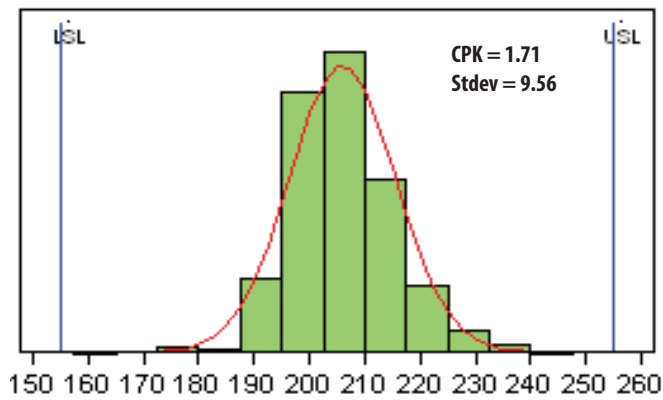

Figure 1. I_{ds} at 2GHz; LSL=155mA, nominal=206mA, USL=255mA.

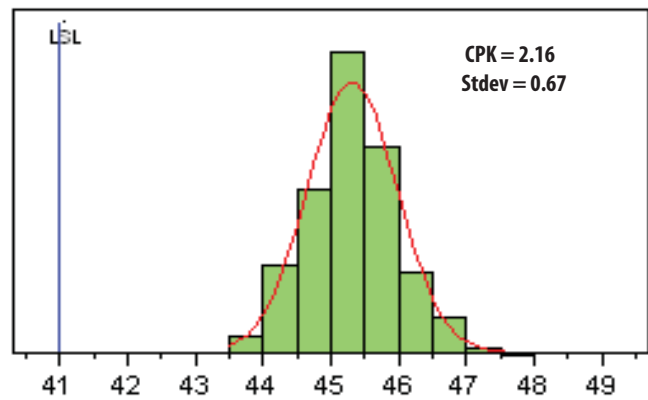

Figure 2. OIP3 at 2GHz; LSL=41dBm, nominal=45.3dBm

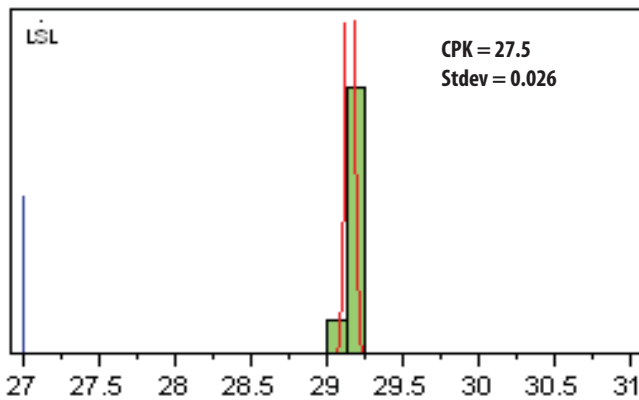

Figure 3. P1dB at 2GHz; LSL=27dBm, nominal=29dBm

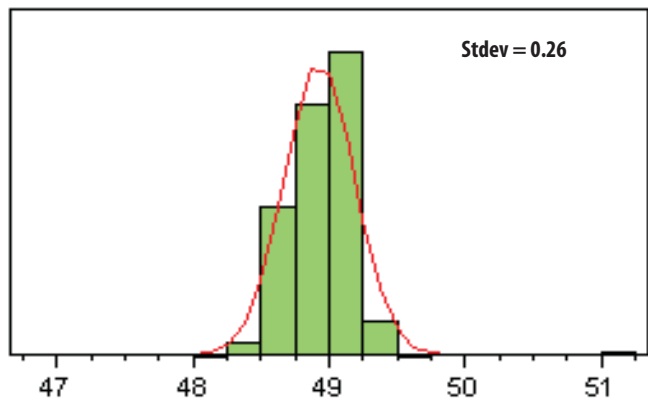

Figure 4. PAE@P1dB 2GHz; nominal=48.9%

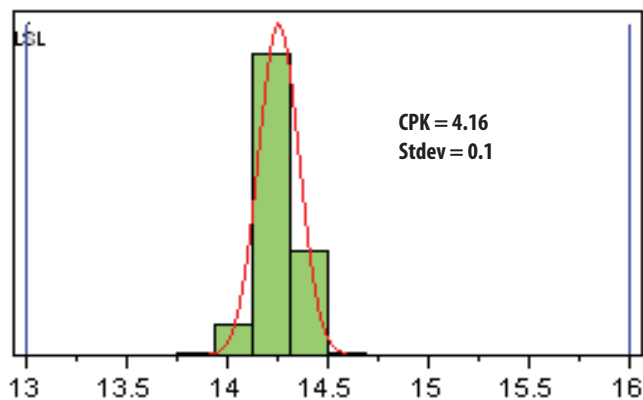

Figure 5. Gain at 2GHz; LSL=13dB, nominal=14.2dB, USL=16dB

Notes:

1. Distribution data sample size is 500 samples taken from 4 different wafer lots and 6 different wafers. Future wafers allocated to this product may have nominal values anywhere between the upper and lower limits.
2. Measurements were made on a characterization test board, which represents a trade-off between optimal OIP3, gain, P1dB and PAE. Circuit trace losses have not been de-embedded from measurements above.

S-Parameter (Vdd=5V, Vctrl=5V, T=25°C, unmatched 50 ohm)

Frequency (GHz)	S11 (dB)	S11 (ang)	S21 (dB)	S21 (ang)	S12 (dB)	S12 (ang)	S22 (dB)	S22 (ang)
0.1	-10.71	-149.41	27.31	158.68	-44.45	94.97	-13.94	-124.42
0.2	-8.74	-136.45	27.45	143.15	-36.55	73.37	-6.44	-128.91
0.3	-4.24	-140.58	26.47	116.93	-34.55	52.67	-4.54	-151.01
0.4	-3.03	-156.66	23.96	101.68	-34.04	45.20	-4.54	-163.18
0.5	-2.63	-166.42	21.96	92.55	-33.37	42.55	-4.70	-169.24
0.6	-2.56	-173.49	20.38	86.52	-32.78	41.51	-4.92	-173.16
0.7	-2.60	-179.40	19.04	81.53	-32.16	41.32	-5.22	-176.42
0.8	-2.64	175.58	17.98	76.56	-31.50	40.63	-5.50	-178.87
0.9	-2.80	171.06	17.08	72.84	-30.87	42.15	-6.01	179.96
1	-3.08	167.34	16.38	69.62	-29.57	41.72	-6.10	-179.66
1.1	-3.20	163.79	15.84	64.89	-28.72	38.49	-6.27	178.32
1.2	-3.41	160.24	15.38	60.59	-27.95	36.04	-6.63	176.84
1.3	-3.71	156.26	14.92	56.22	-27.22	33.65	-7.10	175.28
1.4	-4.02	152.62	14.57	51.41	-26.46	30.49	-7.60	174.32
1.5	-4.43	148.99	14.28	46.50	-25.69	27.19	-8.19	173.90
1.6	-4.91	145.95	14.03	41.44	-25.07	23.42	-8.94	173.30
1.7	-5.44	142.67	13.80	35.74	-24.35	19.17	-9.75	174.15
1.8	-6.07	140.25	13.62	29.89	-23.65	14.44	-10.62	176.31
1.9	-6.84	138.21	13.40	23.63	-23.05	9.20	-11.68	179.90
2	-7.64	137.75	13.21	16.97	-22.54	3.37	-12.70	-173.99
2.1	-8.39	138.68	13.01	9.68	-22.06	-2.78	-13.42	-164.40
2.2	-9.18	141.87	12.74	2.20	-21.66	-8.84	-13.56	-151.42
2.3	-9.67	147.31	12.42	-5.82	-21.30	-15.63	-12.77	-139.56
2.4	-9.58	153.98	12.07	-13.99	-21.00	-22.94	-11.44	-132.30
2.5	-8.98	160.39	11.61	-22.25	-20.84	-30.27	-9.93	-128.17
2.6	-7.99	164.38	11.05	-30.91	-20.83	-38.01	-8.52	-127.33
2.7	-6.81	165.01	10.47	-39.42	-20.86	-45.81	-7.29	-129.17
2.8	-5.71	164.00	9.75	-47.64	-21.04	-53.21	-6.26	-131.98
2.9	-4.75	161.36	8.89	-56.01	-21.37	-60.69	-5.41	-135.70
3	-3.91	157.56	8.05	-63.86	-21.73	-67.92	-4.74	-139.90
3.1	-3.22	153.78	7.11	-71.04	-22.19	-74.54	-4.21	-144.18
3.2	-2.68	149.61	6.05	-78.10	-22.80	-80.69	-3.83	-148.53
3.3	-2.24	145.47	5.03	-84.66	-23.38	-86.66	-3.53	-152.81
3.4	-1.86	141.92	4.01	-90.35	-23.96	-91.94	-3.30	-156.68
3.5	-1.61	138.62	2.85	-95.81	-24.69	-96.66	-3.19	-160.31
3.6	-1.37	135.30	1.79	-101.10	-25.38	-101.33	-3.13	-163.85
3.7	-1.17	132.77	0.75	-105.56	-26.02	-105.51	-3.09	-166.84
3.8	-1.05	130.49	-0.40	-109.88	-26.77	-109.16	-3.16	-169.53
3.9	-0.94	128.36	-1.50	-114.00	-27.51	-112.86	-3.28	-171.85
4	-0.81	126.58	-2.57	-117.75	-28.20	-116.53	-3.42	-173.44
4.1	-0.74	125.32	-3.76	-120.97	-29.08	-119.46	-3.67	-174.23
4.2	-0.71	123.91	-4.99	-124.04	-29.98	-122.53	-3.91	-174.26
4.3	-0.61	122.69	-6.15	-126.10	-30.87	-124.76	-4.04	-173.02
4.4	-0.56	122.14	-7.38	-126.72	-31.89	-125.54	-4.04	-170.97
4.5	-0.55	121.26	-8.51	-126.72	-32.85	-125.23	-3.85	-169.37
4.6	-0.51	120.36	-9.39	-126.13	-33.60	-124.18	-3.51	-168.45
4.7	-0.50	120.08	-10.16	-125.10	-34.24	-122.42	-3.20	-168.29
4.8	-0.51	119.40	-10.83	-125.05	-34.70	-121.18	-2.94	-168.93
4.9	-0.50	118.83	-11.38	-125.16	-35.06	-120.36	-2.73	-169.92
5	-0.49	118.65	-11.89	-125.37	-35.38	-119.96	-2.57	-170.91
5.1	-0.55	118.22	-12.48	-126.23	-35.78	-119.59	-2.49	-172.03
5.2	-0.55	117.50	-12.94	-127.20	-36.08	-119.78	-2.42	-173.27
5.3	-0.56	117.19	-13.40	-127.99	-36.34	-119.65	-2.39	-174.37
5.4	-0.64	116.57	-13.97	-129.39	-36.73	-120.11	-2.39	-175.57
5.5	-0.69	115.68	-14.43	-130.81	-37.07	-120.31	-2.40	-176.92
5.6	-0.72	115.06	-14.85	-131.97	-37.40	-119.64	-2.43	-178.32
5.7	-0.83	114.30	-15.39	-133.47	-37.47	-118.99	-2.48	-179.64
5.8	-0.94	113.17	-15.85	-135.22	-37.56	-120.68	-2.51	178.79
5.9	-1.03	112.12	-16.27	-136.81	-37.81	-121.89	-2.55	177.07
6	-1.21	111.19	-16.80	-138.69	-38.13	-123.32	-2.60	175.15

S-Parameter Test Circuit

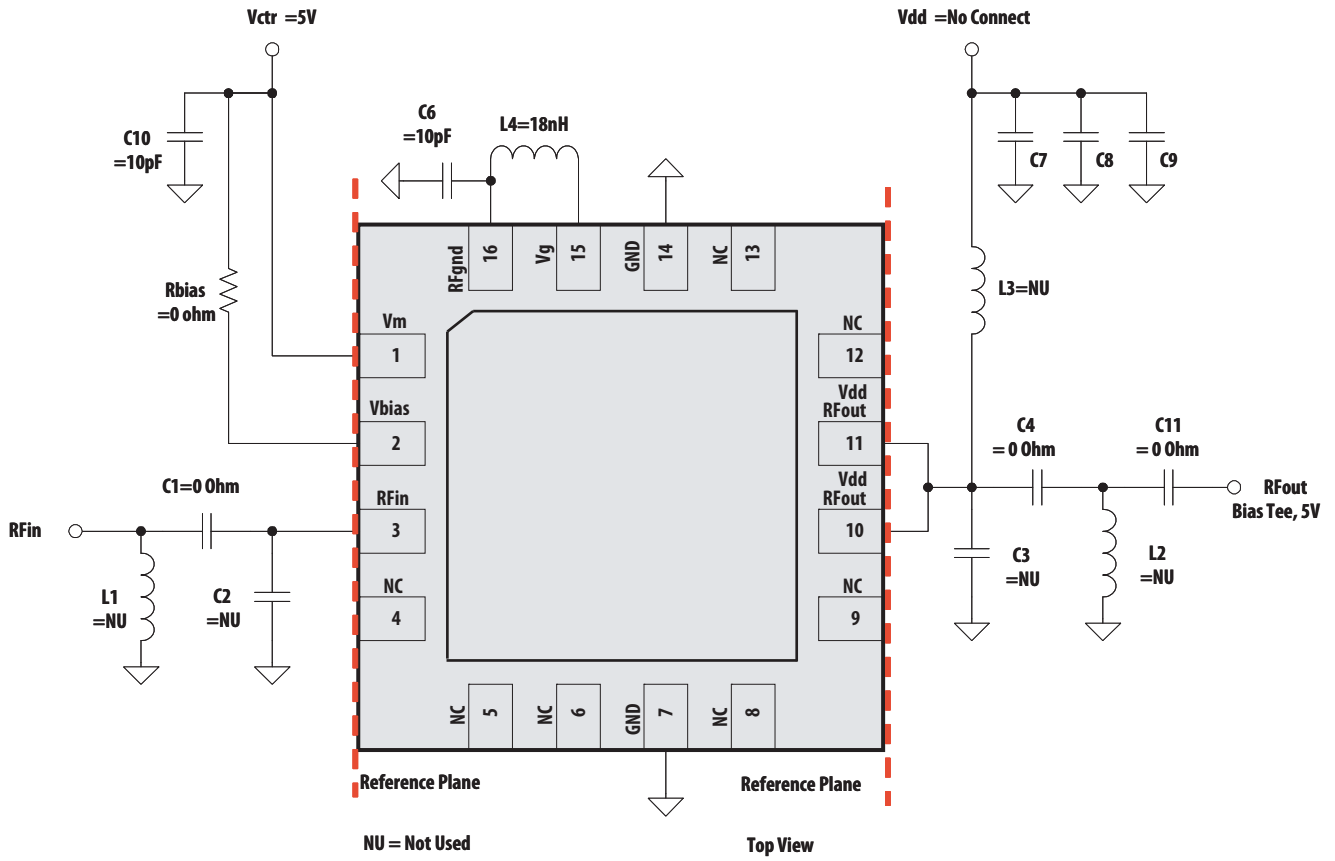

Demo Board

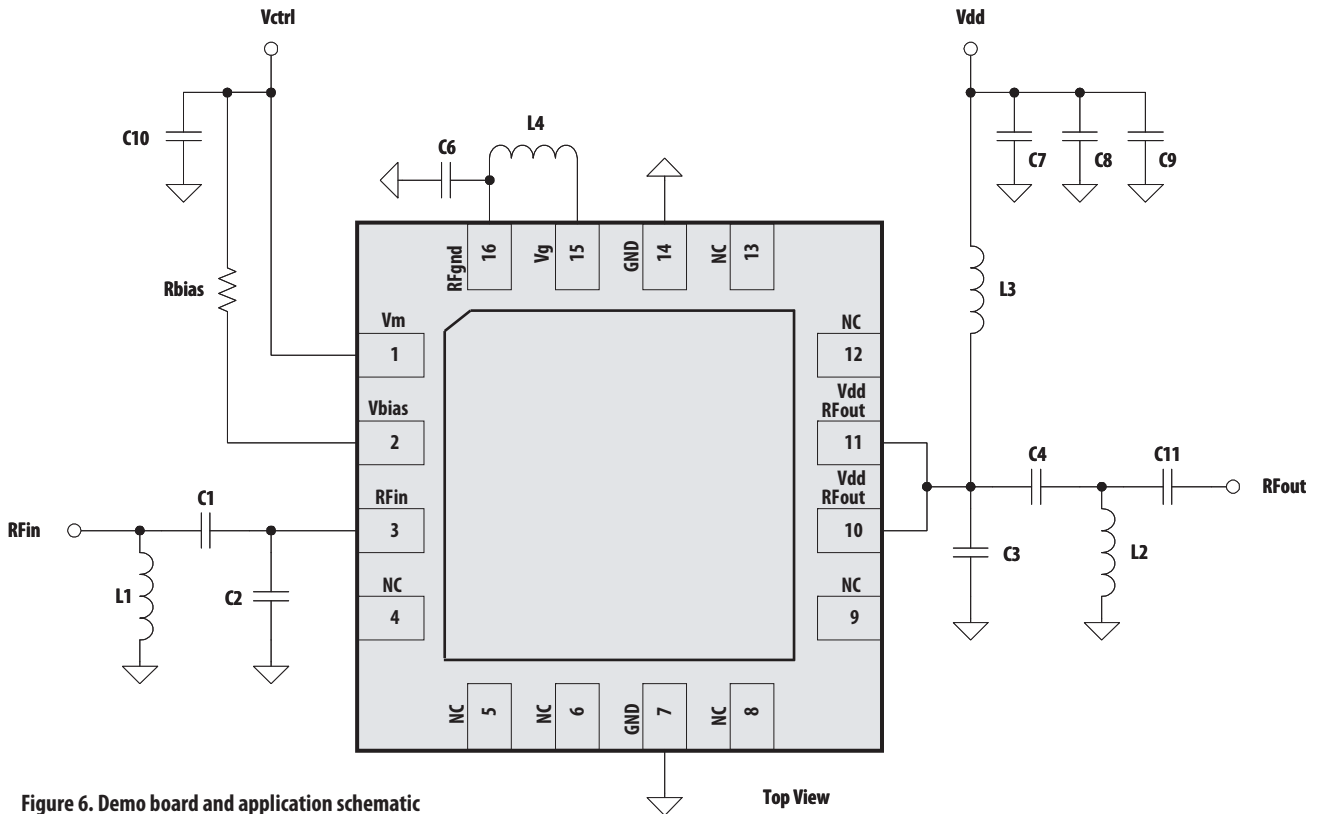

Figure 6. Demo board and application schematic

Demo Board Part List

Circuit Symbol	Size	1.7-2.5GHz		2.4-2.7GHz		Description
		Value	Part Number	Value	Part Number	
L1	0402	2.2nH	LLP1005-FH2N2C (Toko)	3.9nH	LLP1005-FH3N9C (Toko)	MLC Inductor
L2	0402	2.2nH	LLP1005-FH2N2C (Toko)	1.2nH	LLP1005-FH1N2B (Toko)	MLC Inductor
L3	0402	1.0nH	LLP1005-FH1N0B (Toko)	2.2nH	LLP1005-FH2N2C (Toko)	MLC Inductor
L4	0402	18nH	MLK1005S18NJ (TDK)	18nH	MLK1005S18NJ (TDK)	MLC Inductor
C1	0402	1.8pF	GJM1555C1H1R8BB01 (Murata)	2.4pF	GJM1555C1H2R4BB01 (Murata)	Ceramic Chip Capacitor
C2	0402	NU		1.3pF	GJM1555C1H1R3BB01 (Murata)	Ceramic Chip Capacitor
C3	0402	2.4pF	GJM1555C1H2R4BB01 (Murata)	1.6pF	GJM1555C1H1R6BB01 (Murata)	Ceramic Chip Capacitor
C4	0402	2pF	GJM1555C1H2R0BB01 (Murata)	1.8pF	GJM1555C1H1R8BB01 (Murata)	Ceramic Chip Capacitor
C6	0402	10pF	GJM1555C1H100CB01 (Murata)	10pF	GJM1555C1H100CB01 (Murata)	Ceramic Chip Capacitor
C7	0402	0.1uF	GRM155R71C104KA88D (Murata)	0.1uF	GRM155R71C104KA88D (Murata)	Ceramic Chip Capacitor
C8	0402	20pF	GJM1555C1H200JB01 (Murata)	20pF	GJM1555C1H200JB01 (Murata)	Ceramic Chip Capacitor
C9	0805	2.2uF	GRM21BR61E225KA12L (Murata)	2.2uF	GRM21BR61E225KA12L (Murata)	Ceramic Chip Capacitor
C10	0402	10pF	GJM1555C1H100CB01 (Murata)	10pF	GJM1555C1H100CB01 (Murata)	Ceramic Chip Capacitor
C11	0402	20pF	GJM1555C1H200JB01 (Murata)	20pF	GJM1555C1H200JB01 (Murata)	Ceramic Chip Capacitor

Note: Rbias is used to lower the quiescent current. Default is 0 ohm

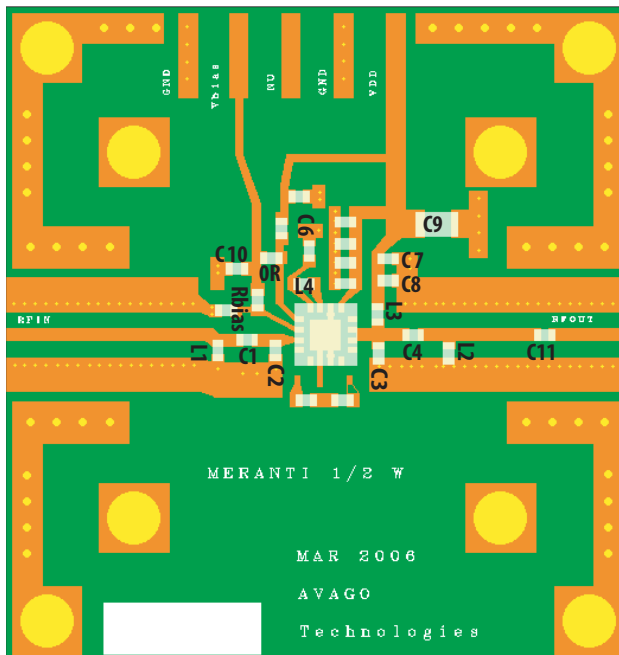

Figure 7. Demo board Layout

- Recommended PCB material is 10 mils Rogers RO4350, with FR4 backing for mechanical strength.
- Suggested component values may vary according to layout and PCB material.

MGA-30216 Typical Performance (1.7 - 2.5GHz demo board)

$T_A = +25^\circ\text{C}$, $V_{dd} = 5\text{V}$, $V_{ctrl} = 5\text{V}$, Input Signal=CW unless stated otherwise.

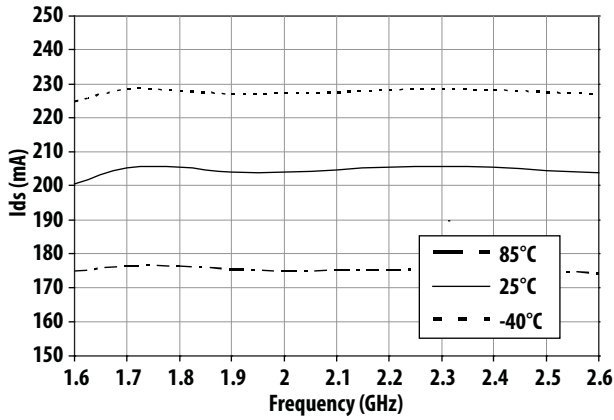

Figure 8. Over Temperature Ids vs Frequency

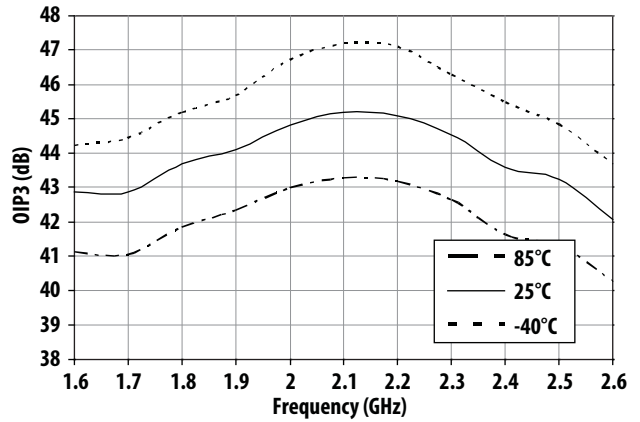

Figure 9. Over Temperature OIP3 vs Frequency

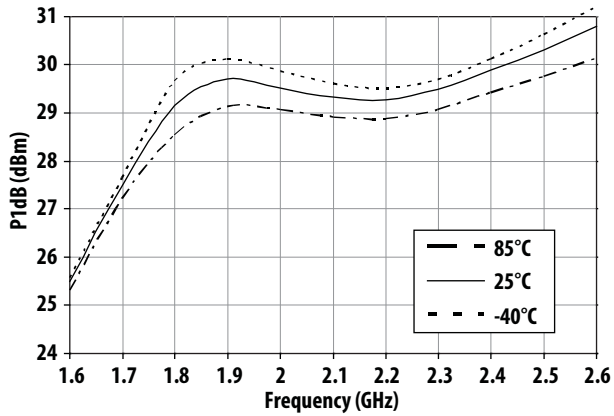

Figure 10. Over Temperature P1dB vs Frequency

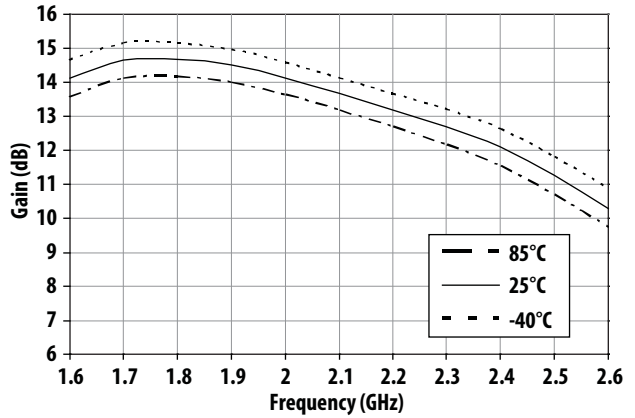

Figure 11. Over Temperature Gain vs Frequency

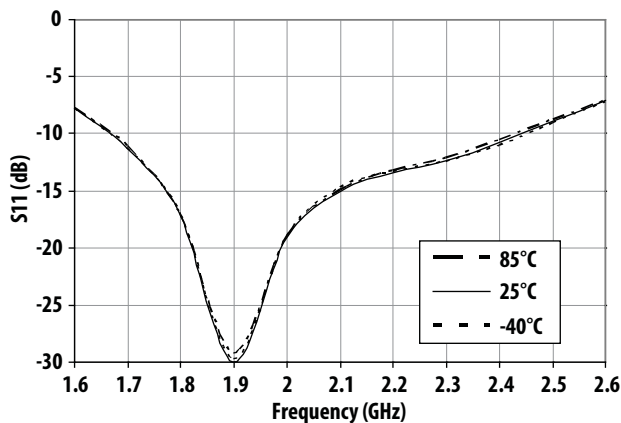

Figure 12. Over Temperature S11 vs Frequency

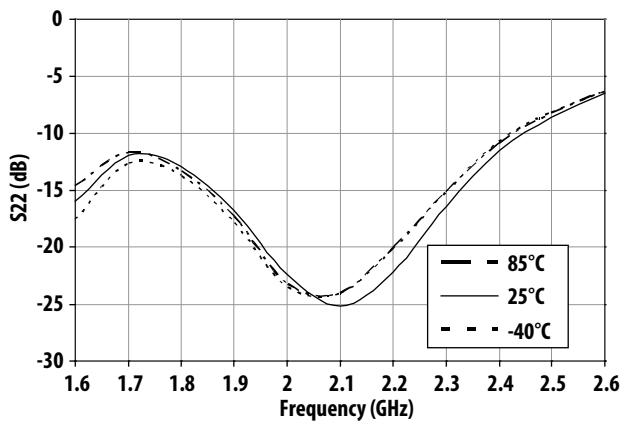

Figure 13. Over Temperature S22 vs Frequency

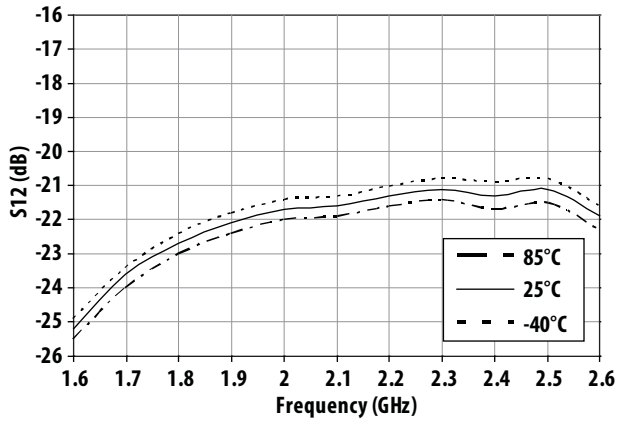

Figure 14. Over Temperature S12 vs Frequency

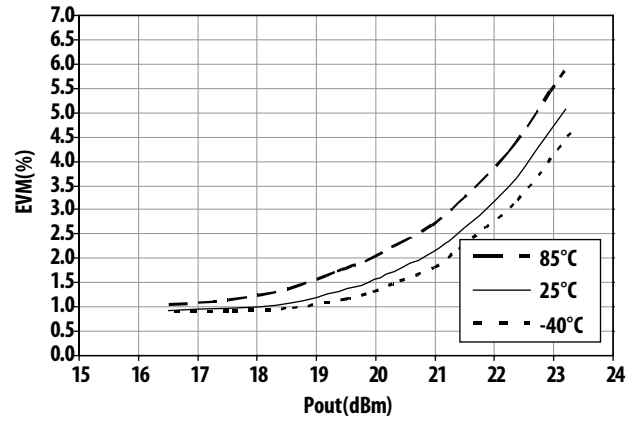

Figure 15. Over temperature EVM vs Pout at 2.5GHz

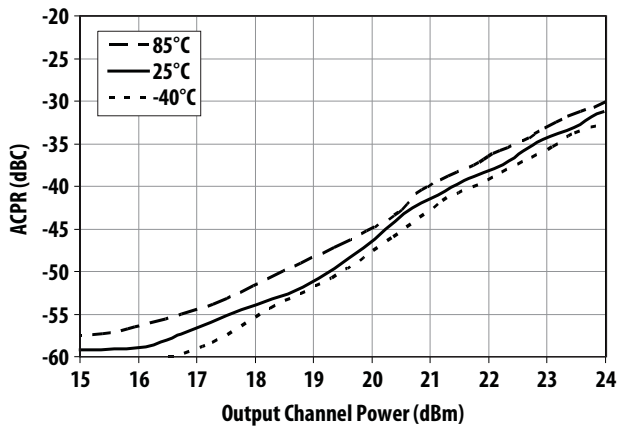

Figure 16. Over Temperature ACPR vs Channel Power at 2.14GHz

MGA-30216 Typical Performance (2.4 - 2.7 GHz demo board)

$T_A = +25^\circ\text{C}$, $V_{dd} = 5\text{V}$, $V_{ctrl} = 5\text{V}$, Input Signal=CW unless stated otherwise.

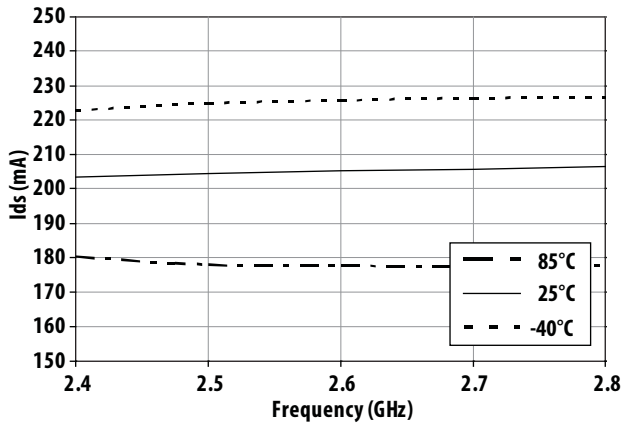

Figure 17. Over temperature Ids vs Frequency

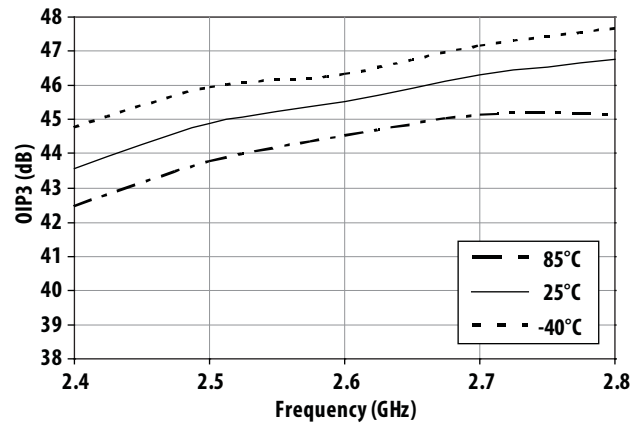

Figure 18. Over temperature OIP3 vs Frequency

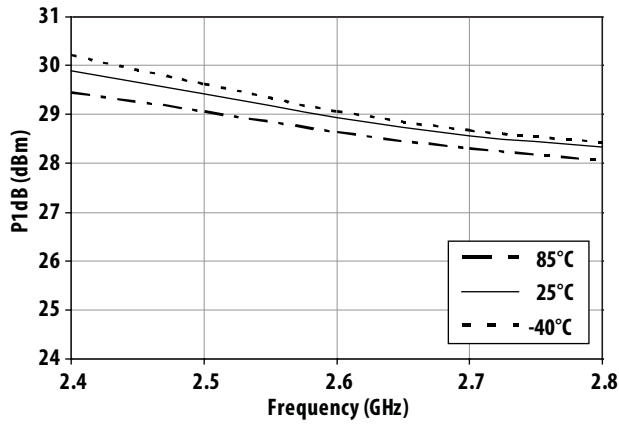

Figure 19. Over temperature P1dB vs Frequency

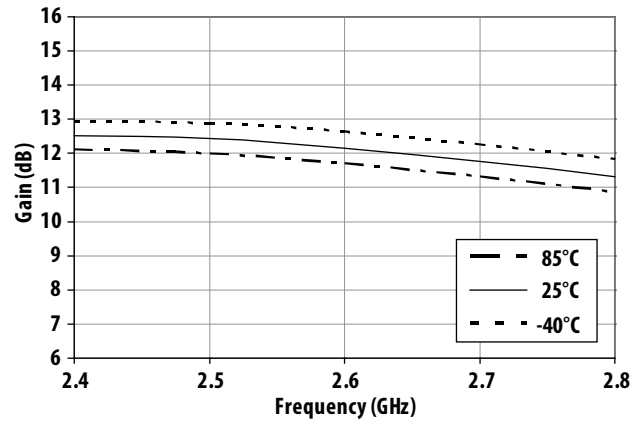

Figure 20. Over temperature Gain vs Frequency

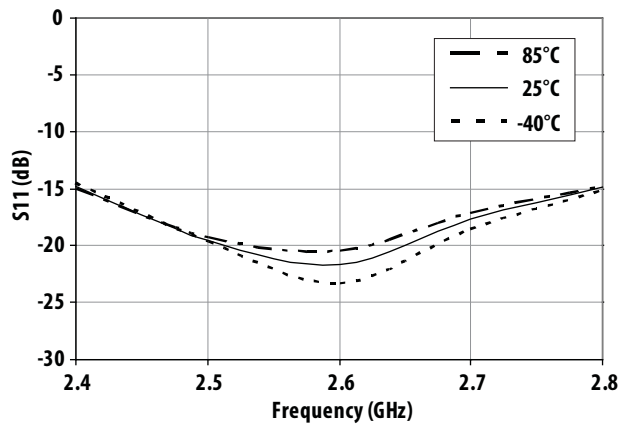

Figure 21. Over temperature S11 vs Frequency

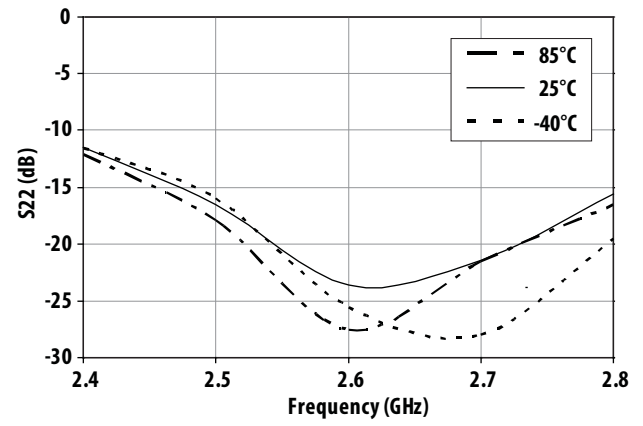

Figure 22. Over temperature S22 vs Frequency

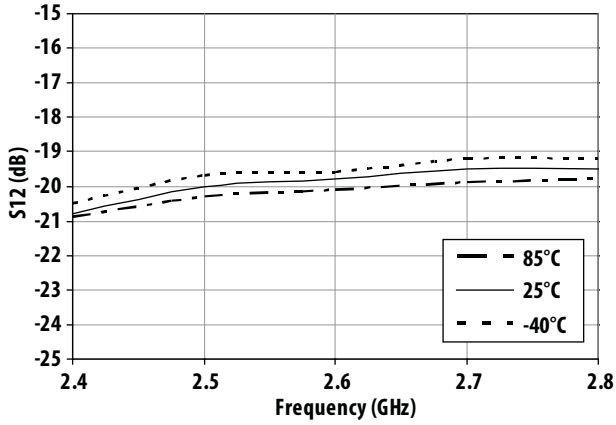

Figure 23. Over temperature S12 vs Frequency

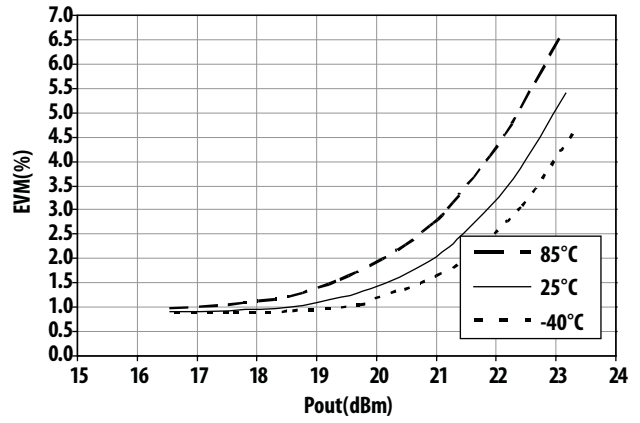

Figure 24. Over temperature EVM vs Pout at 2.5GHz

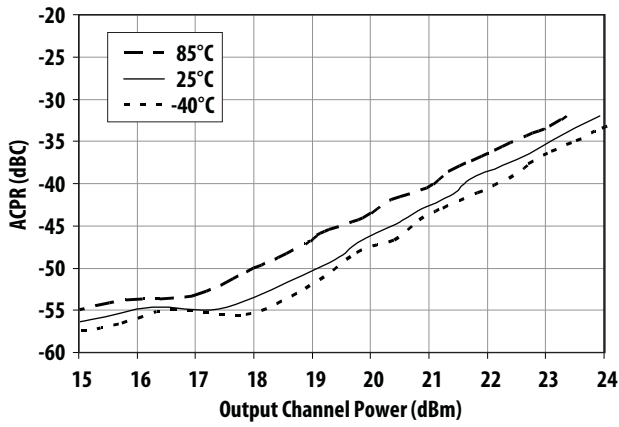

Figure 25. Over temperature ACPR vs Channel Power at 2.5GHz

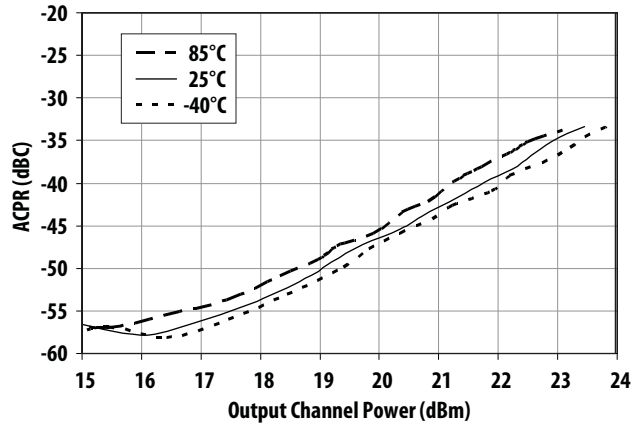

Figure 26. Over temperature ACPR vs Channel Power at 2.6GHz

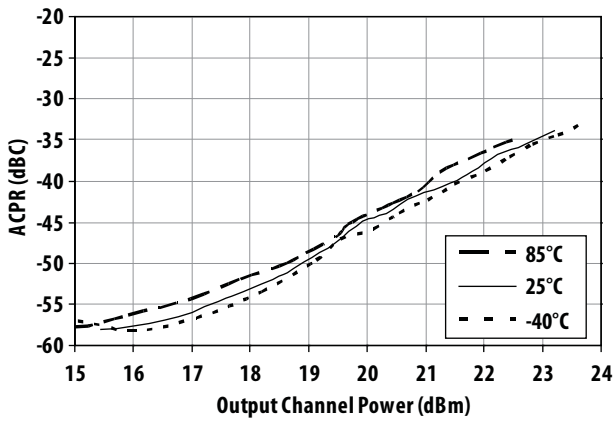
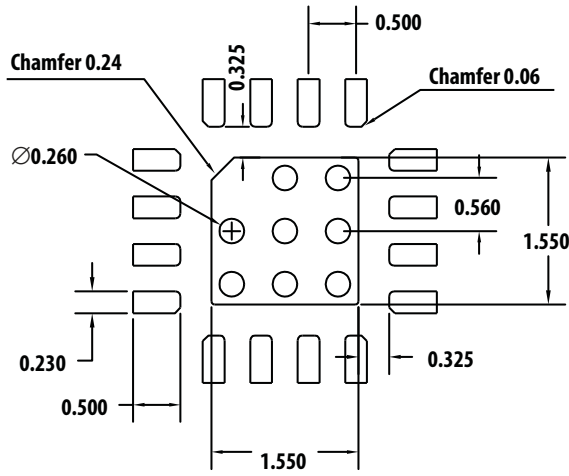
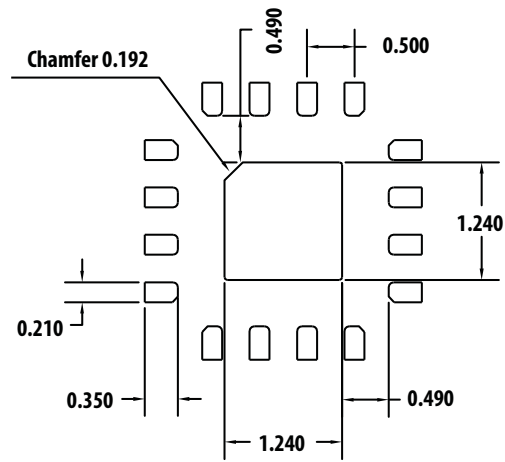

Figure 27. Over temperature ACPR vs Channel Power at 2.7GHz

PCB Layout and Stencil Design



PCB Land Pattern
(Top View)



Stencil Outline

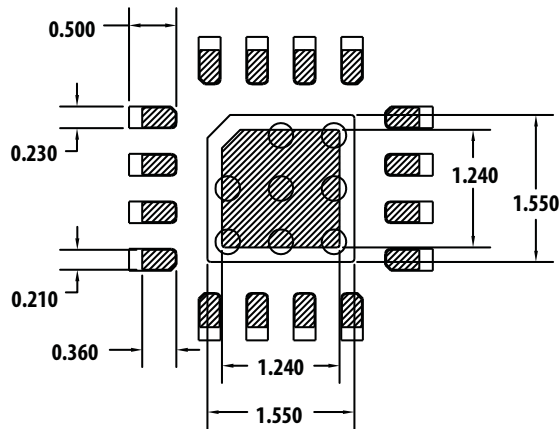

Combined PCB & Stencil Layouts

Notes:

1. All dimensions are in millimeters.

Part Number Ordering Information

Part Number	No. of Devices	Container
MGA-30216-TR1G	1000	7" Reel
MGA-30216-TR2G	3000	13" Reel
MGA-30216-BLKG	100	antistatic bag

Product Family

Output Power	Frequency Band		
	700MHz-1GHz	1.7- 2.7GHz	3.3-3.9GHz
0.5W	MGA-30116	MGA-30216	MGA-30316
1W	ALM-31122	ALM-31222	ALM-31322
2W	ALM-32120	ALM-32220	ALM-32320

Package Dimensions

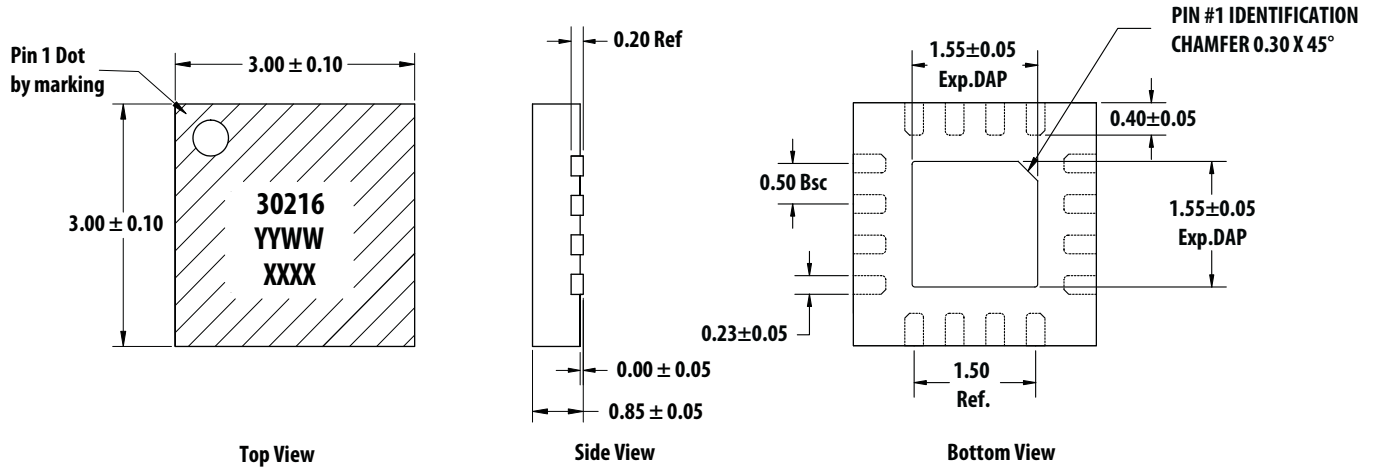

Notes:

1. All dimensions are in millimeters
2. Dimensions are inclusive of plating
3. Dimensions are exclusive of mold flash and metal burr

Device Orientation

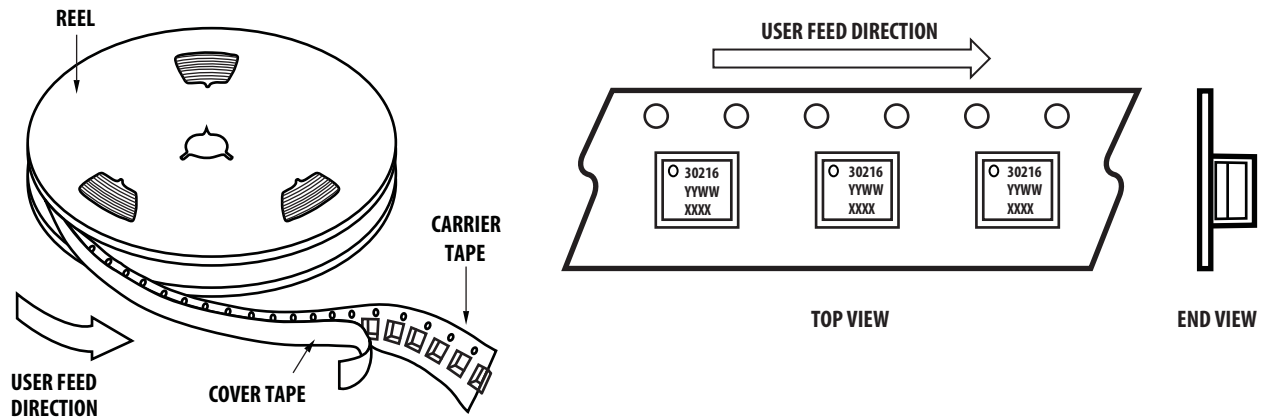

Tape Dimensions

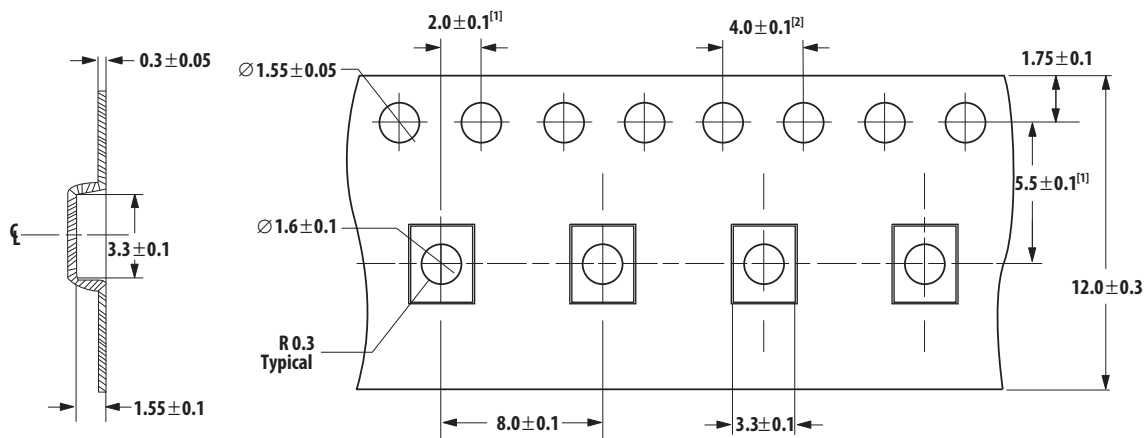

Notes:

1. Measured from centerline of sprocket hole to centerline of pocket
2. Cumulative tolerance of 10 sprocket holes is ± 0.20
3. All dimensions in millimeter unless otherwise stated

Reel Dimension - 7 inch

