

DETAILS

Product Number	C14896_STRADA-2X2-PXL
Family	Strada
Type	Lens
Color	clear
Diameter	50 x 50 mm
Height	8 mm
Style	rectang
Optic Material	PMMA
Holder Material	
Fastening	screw, pin
Status	production ready
ROHS Compliant	Yes
Date Updated	21/04/2016



OPTICAL PROPERTIES

LED	Viewing Angle	Light Beam	Efficiency	cd/lm	Connector
LUXEON MZ	Asymmetric deg	Streetligh...	94 %	0.880	-
NVSxx19B/NVSxx19C	sim: Asymmetric	Streetligh...	sim: 92 %	sim: 1.000	-
NVSxE21A	asym deg	Streetligh...	94 %	1.430	-
Oslon Square PC	Asymmetric deg	Streetligh...	94 %	1.100	-
Oslon Square Gen3	sim: Asymmetric	Streetligh...	sim: 93 %	sim: 1.200	-
LH351B	Asymmetric deg	Streetligh...	94 %	0.860	-

D

C

B

A

4

4

Cent. to cent.

Rear view

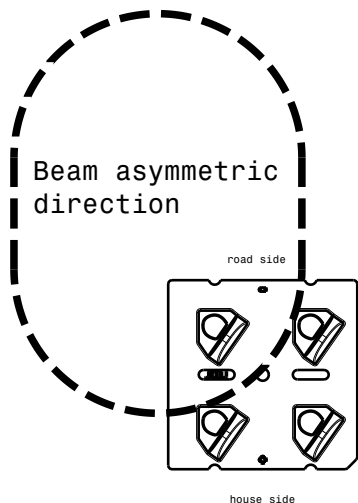
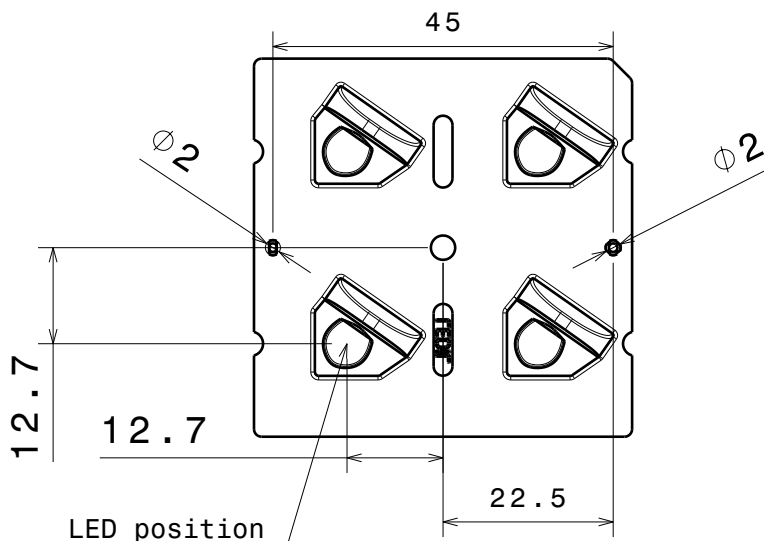

Bottom view

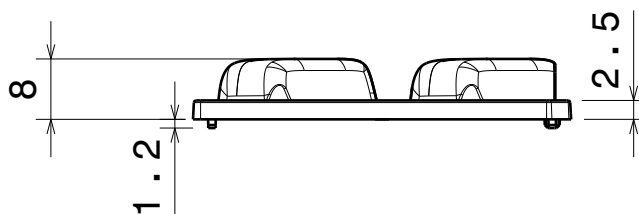

Front view

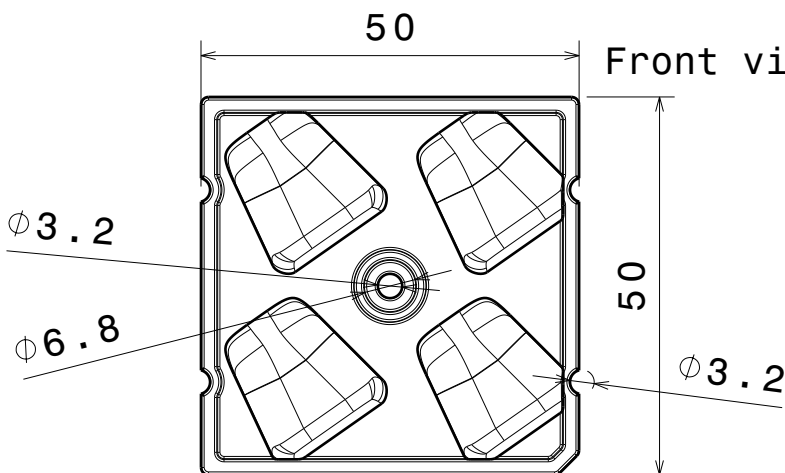

3

3

2

2

INDEX	PART NO	DESCRIPTION	MATERIAL	COLOUR
1	C14896	STRADA-2X2-PXL	PMMA	clear

Tolerances if not otherwise shown
 According to DIN ISO 2768-1
 Linear measures:
 Up to 30mm class M, otherwise class C.
 According to DIN ISO 2768-2
 Form and position: class L

LEDiL

Ledil Oy
 Salorankatu 10
 FIN 24240 SALO
 Finland

THIRD ANGLE PROJECTION:

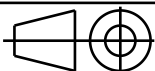

DRAWING TITLE

C14896_STRADA-2X2-PXL

This drawing is the property
 of LEDiL Oy. It may not be
 reproduced, copied or
 communicated without a written
 agreement with LEDiL Oy.

SIZE PART NUMBER

A4

C14896

SCALE 1:1 WEIGHT

SHEET 1/1

D

A

1

1

Luminaire: Ledil C14896_STRADA-2X2-PXL_(Luxeon_MZ)

Lamps: 1 x Philips_Lumileds_Luxeon_MZ_(LMZ7-QW57)_(2x2)_427.268lm@250mA_P=2.734W_η=0.2500A

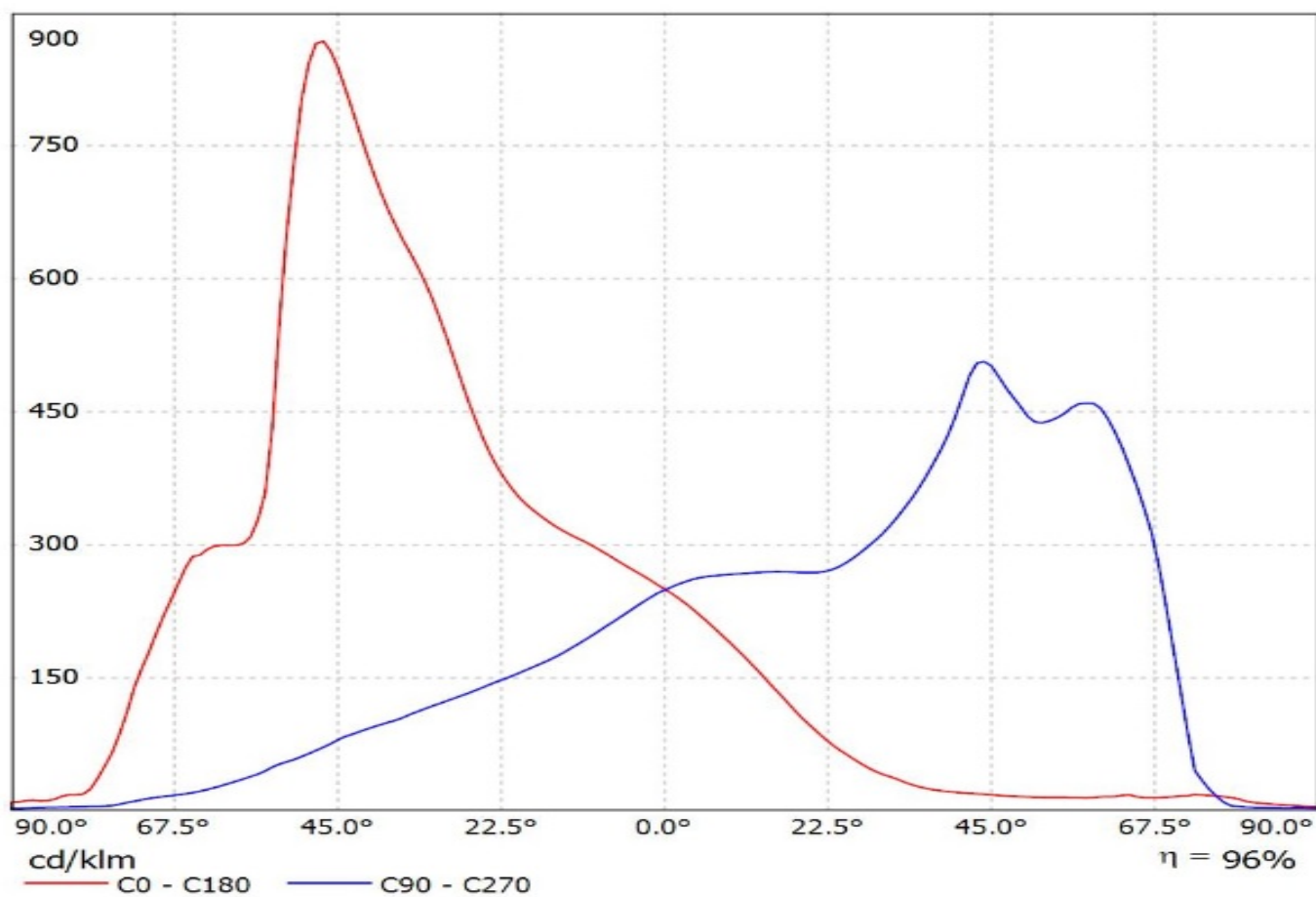

Luminaire: Ledil Oy C14896_STRADA-2X2-PXL_(NVSx219C)_SIMULATED
Lamps: 1 x Nichia NVSxx19C (NVS219c)

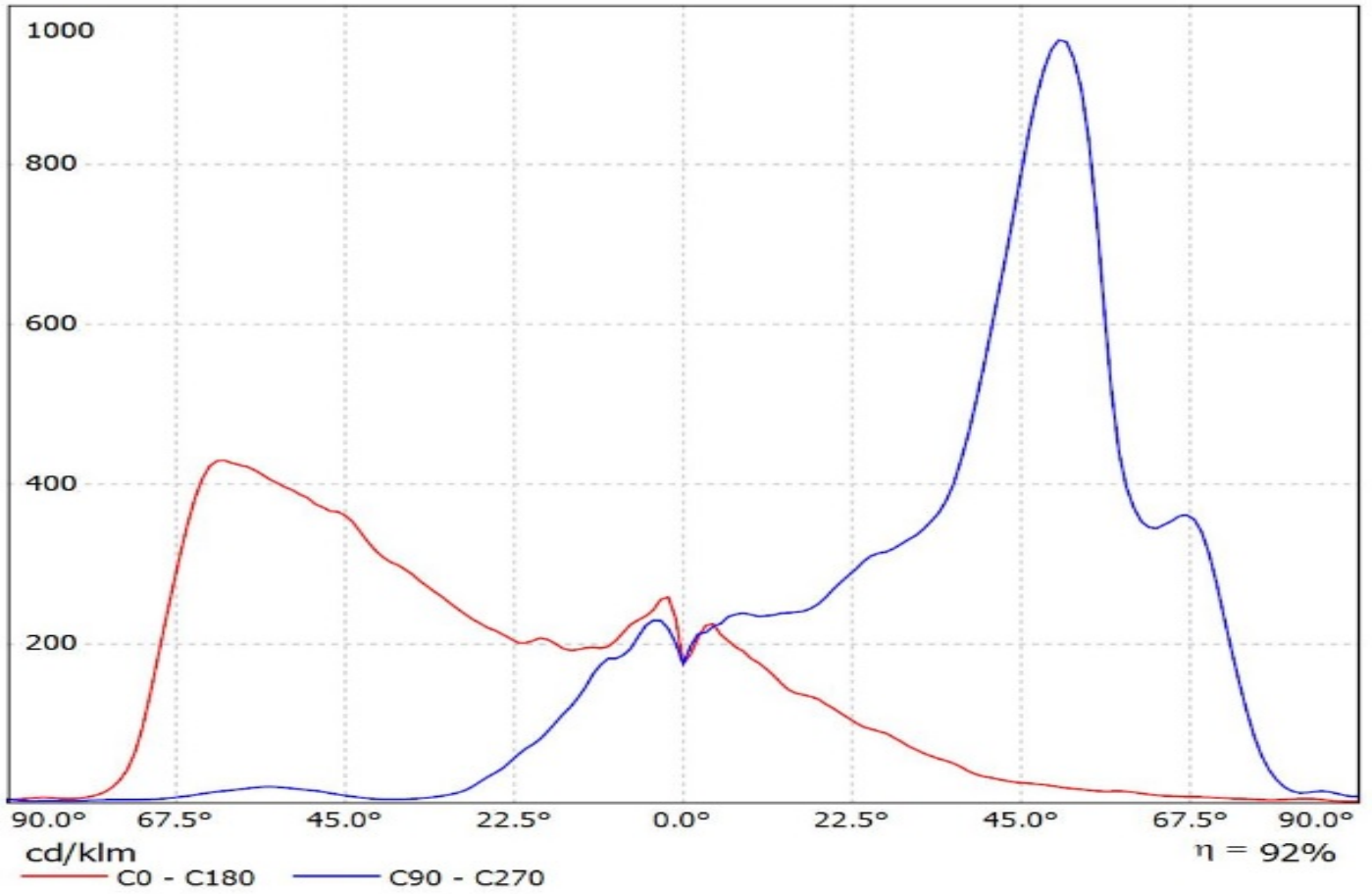

Luminaire: LEDiL Oy C14896_STRADA-2X2-PXL_(E21A)
Lamps: 1 x Nichia_E21A_452.248lm@250mA_2.805W_I=0.250A

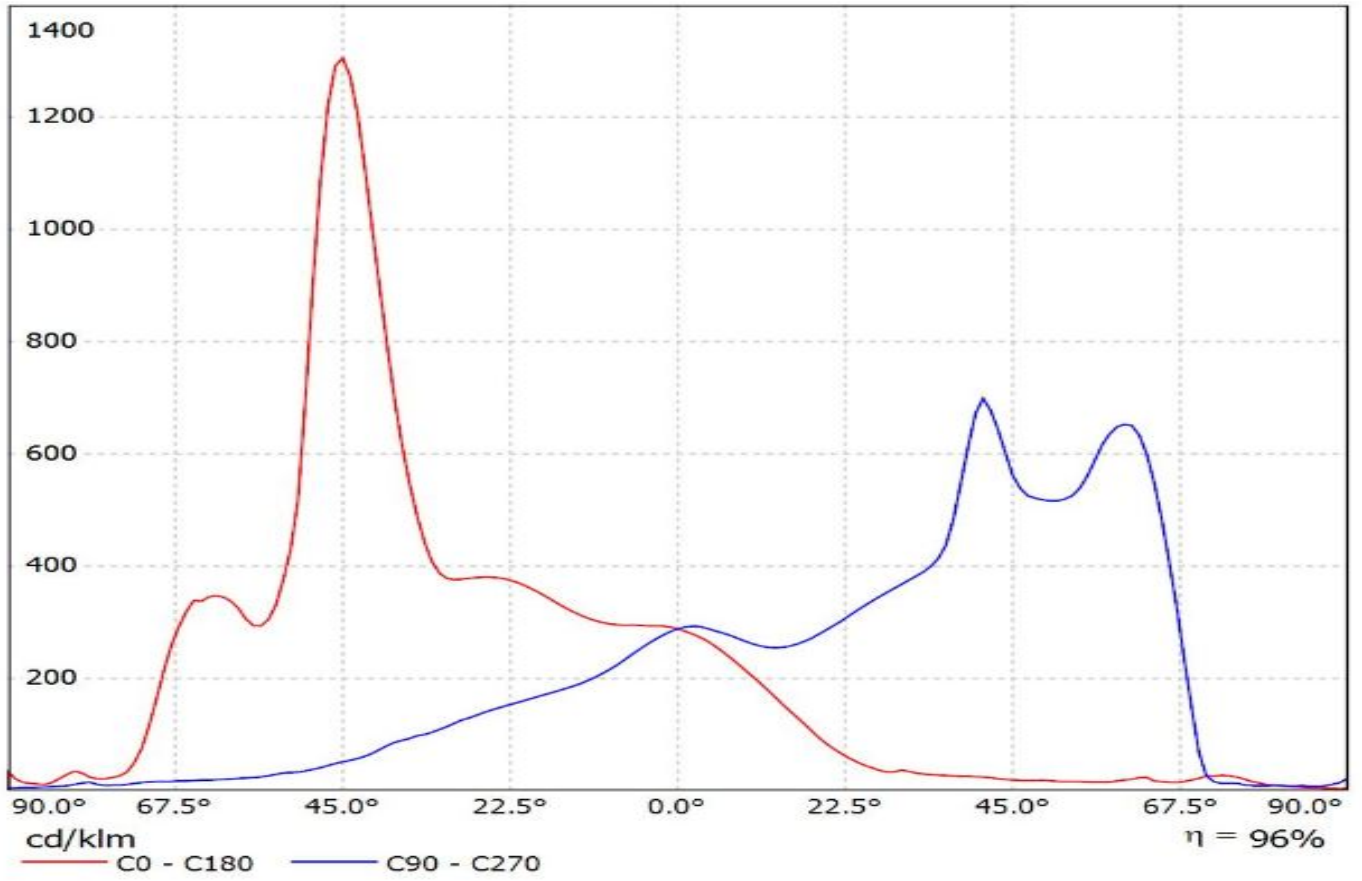

LEDiL Oy C14896_STRADA-2X2-PXL_(Oslon_Square_PC) / LDC (Linear)

Luminaire: LEDiL Oy C14896_STRADA-2X2-PXL_(Oslon_Square_PC)
Lamps: 1 x Osram_Oslon_Square_PC_(LCW_CQAR.PC-MSMU-5H71-1)_(2x2)
_389.916lm@250mA_P=2.96082W_I=0.2499A

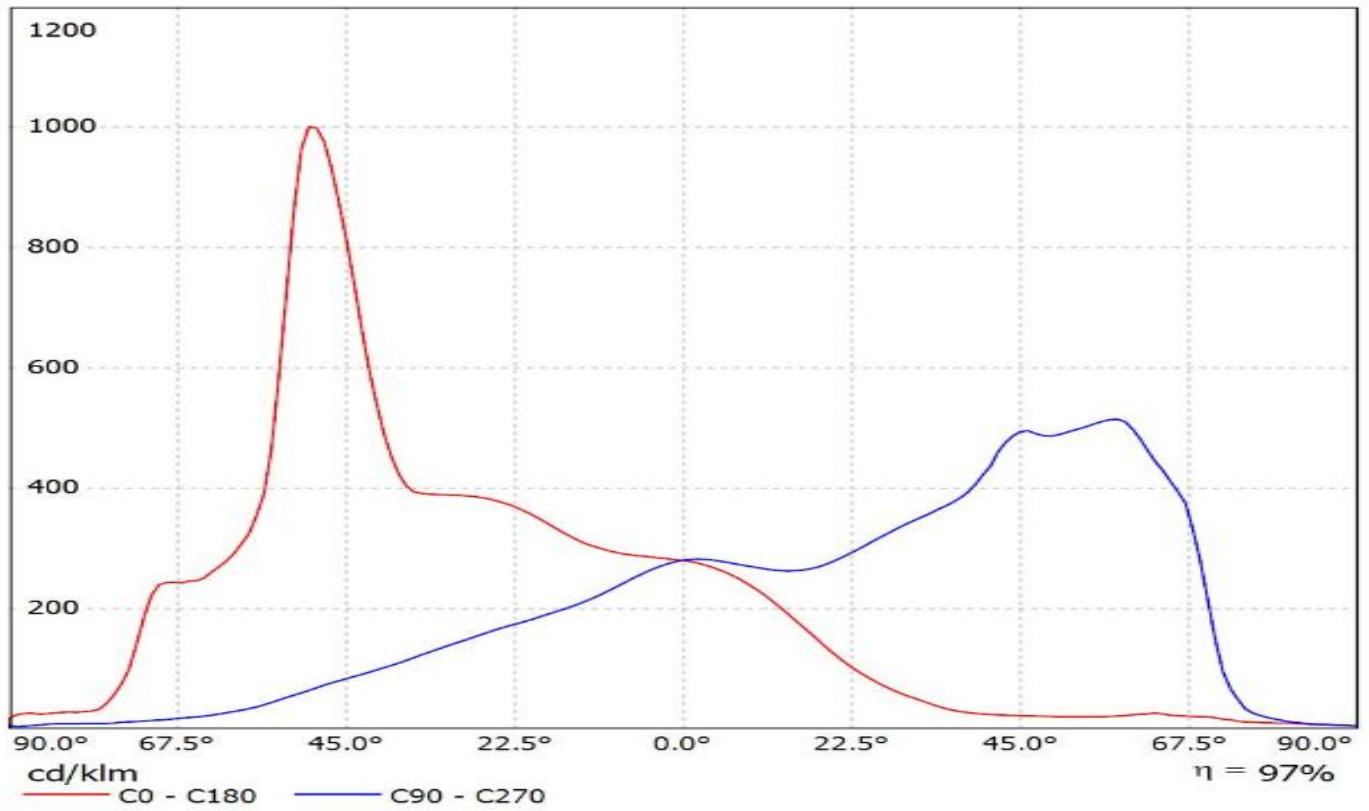

Luminaire: Ledil Oy C14896_STRADA-2X2-PXL_(Oslon_Square_Gen3)_SIMULATED
Lamps: 1 x Osram Oslon Square Gen3 (GW CSSRM2.PC)

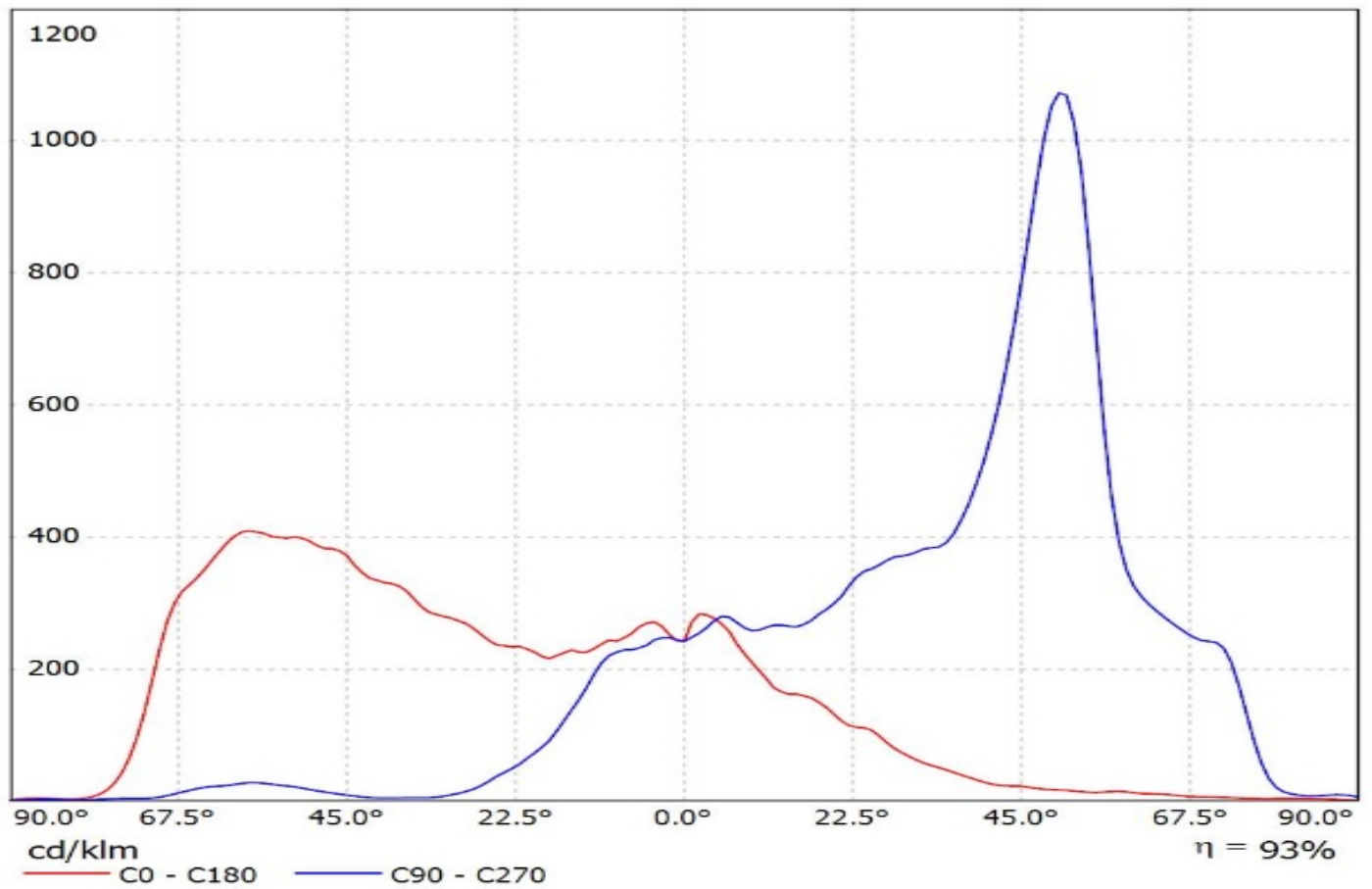

Luminaire: Ledil C14896_STRADA-2X2-PXL_(LH351B)

Lamps: 1 x Samsung_LH351B_2x2_444.178lm@250mA_P=2.8535W_I=0.25A

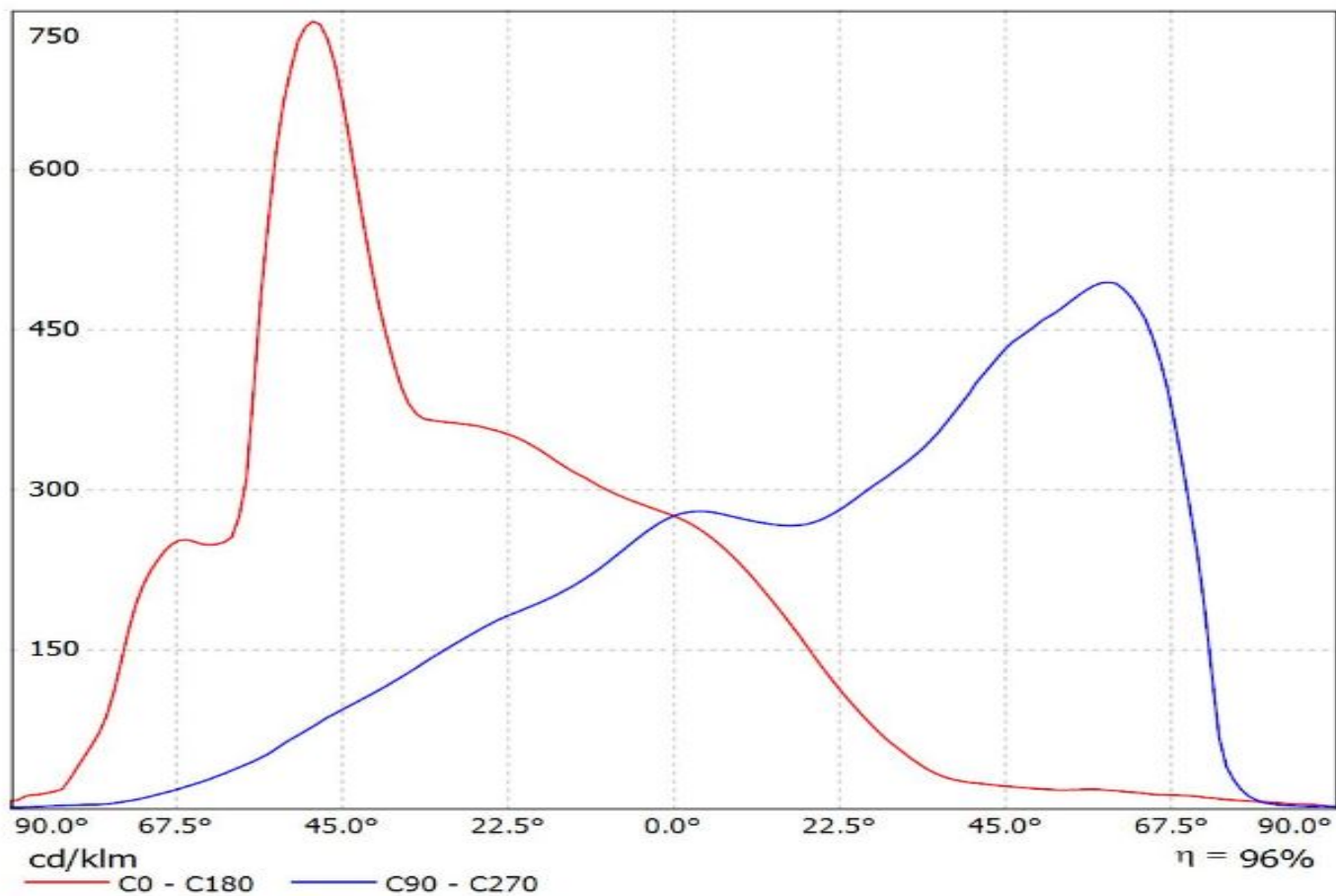

Luminaire: Ledil C14896_STRADA-2X2-PXL_(Luxeon_MZ)

Lamps: 1 x Philips_Lumileds_Luxeon_MZ_(LMZ7-QW57)_(2x2)_427.268lm@250mA_P=2.734W_I=0.2500A

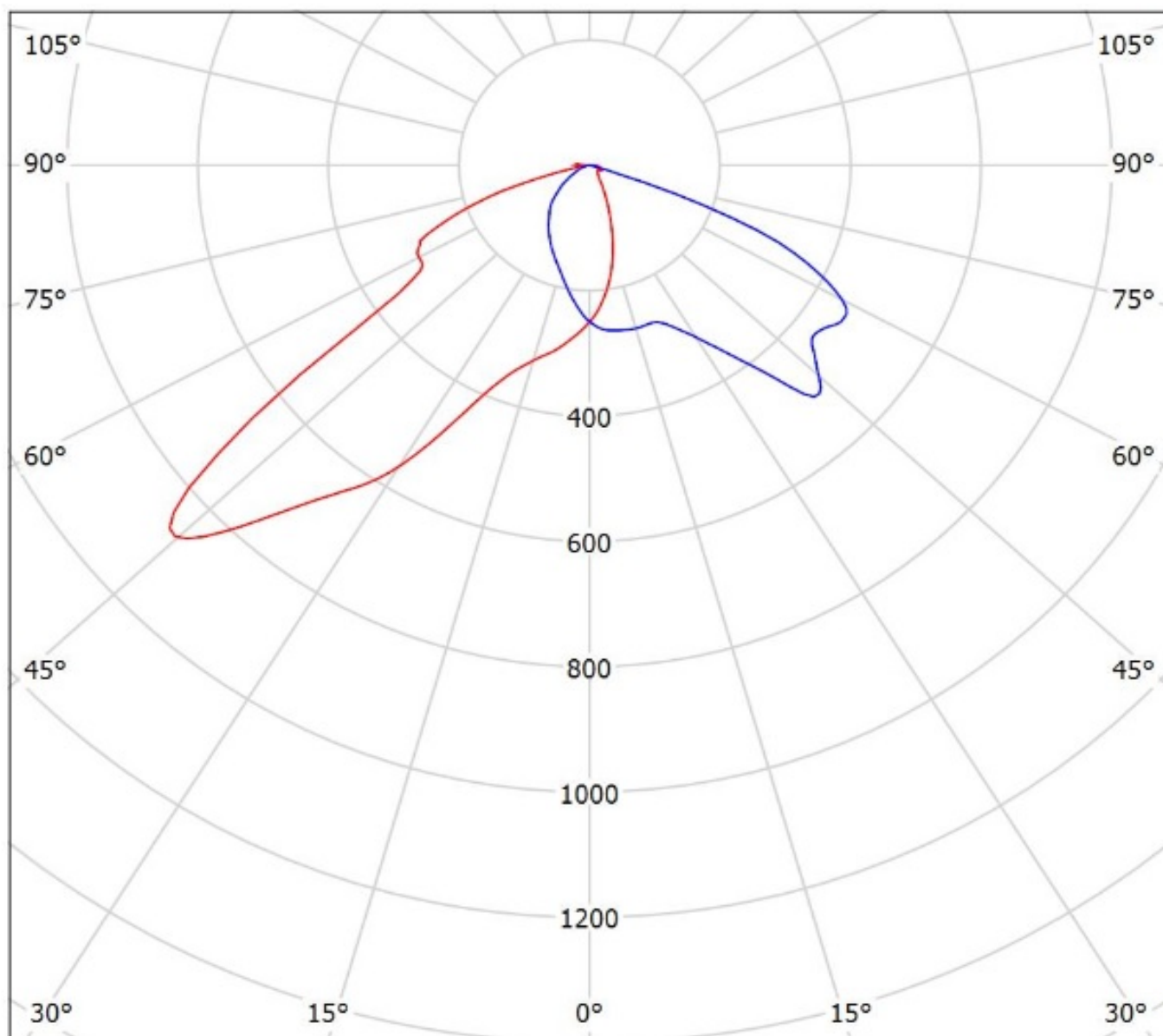

cd/klm

— C0 - C180 — C90 - C270

$\eta = 96\%$

Luminaire: Ledil Oy C14896_STRADA-2X2-PXL_(NVSx219C)_SIMULATED
Lamps: 1 x Nichia NVSxx19C (NVSW219c)

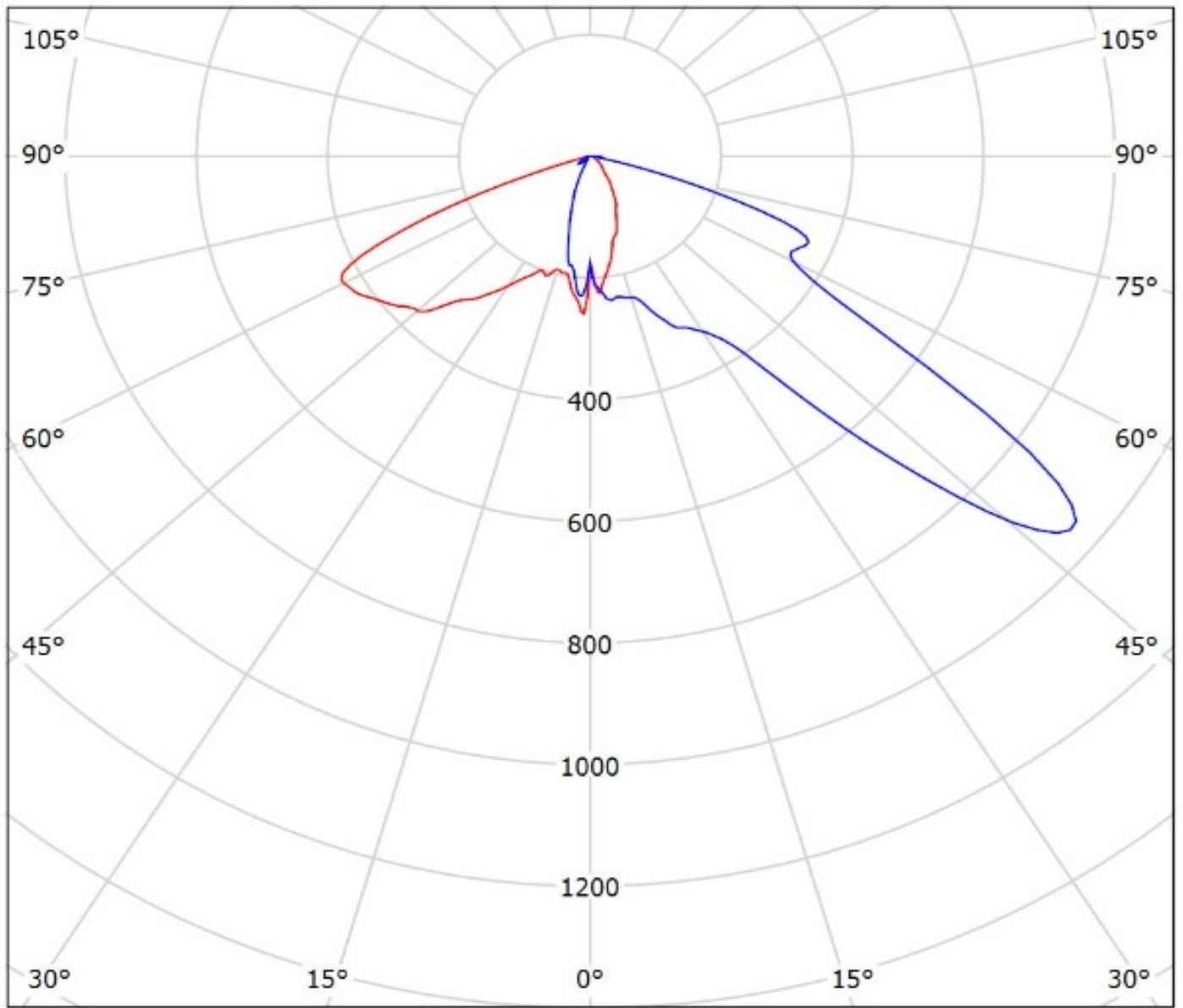

cd/klm
— C0 - C180 — C90 - C270

$\eta = 92\%$

Luminaire: LEDiL Oy C14896_STRADA-2X2-PXL_(E21A)
Lamps: 1 x Nichia_E21A_452.248lm@250mA_2.805W_I=0.250A

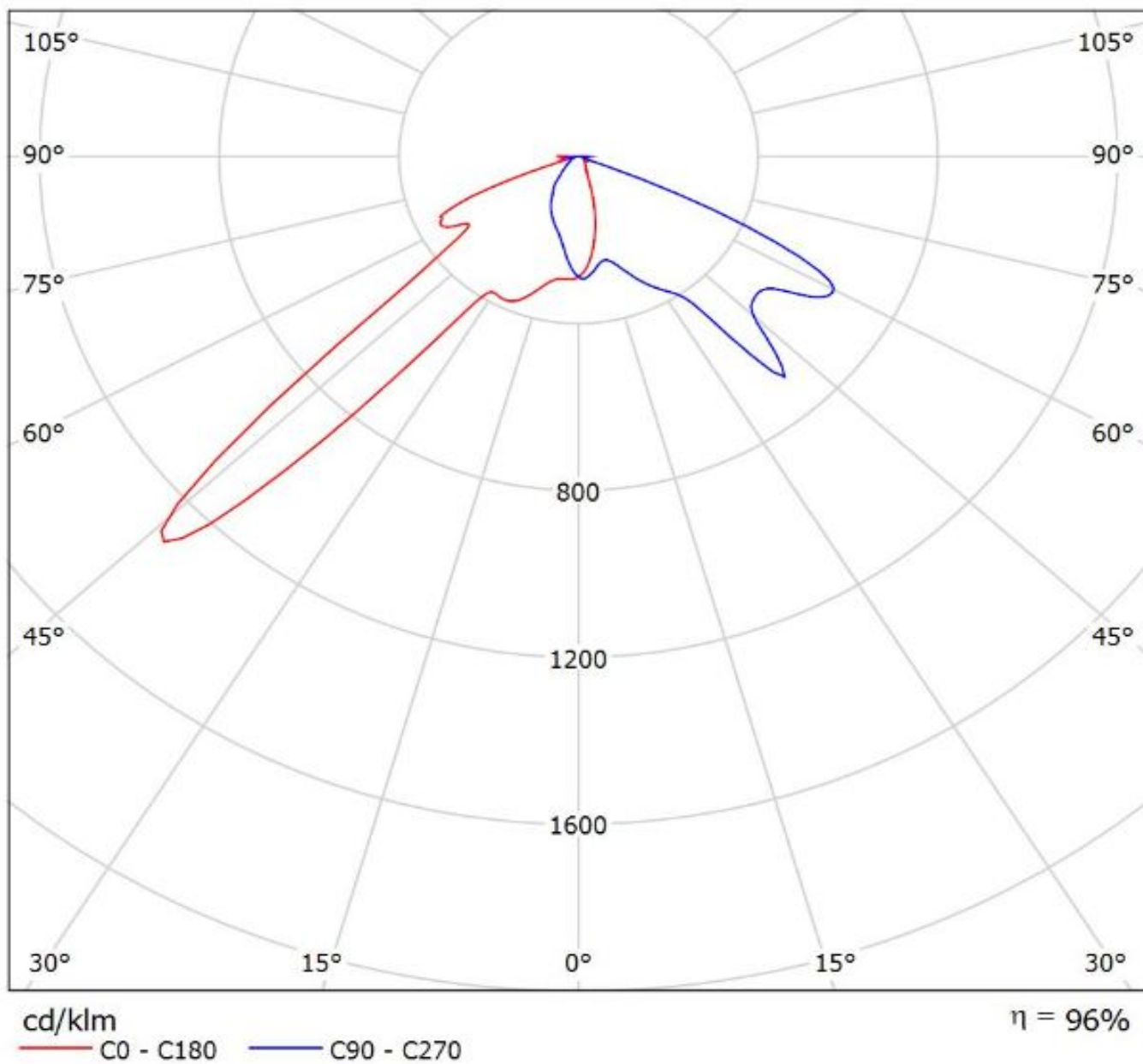

LEDiL Oy C14896_STRADA-2X2-PXL_(Oslon_Square_PC) / LDC (Polar)

Luminaire: LEDiL Oy C14896_STRADA-2X2-PXL_(Oslon_Square_PC)

Lamps: 1 x Osram_Oslon_Square_PC_(LCW_CQAR.PC-MSMU-5H71-1)_(2x2)

_389.916lm@250mA_P=2.96082W_I=0.2499A

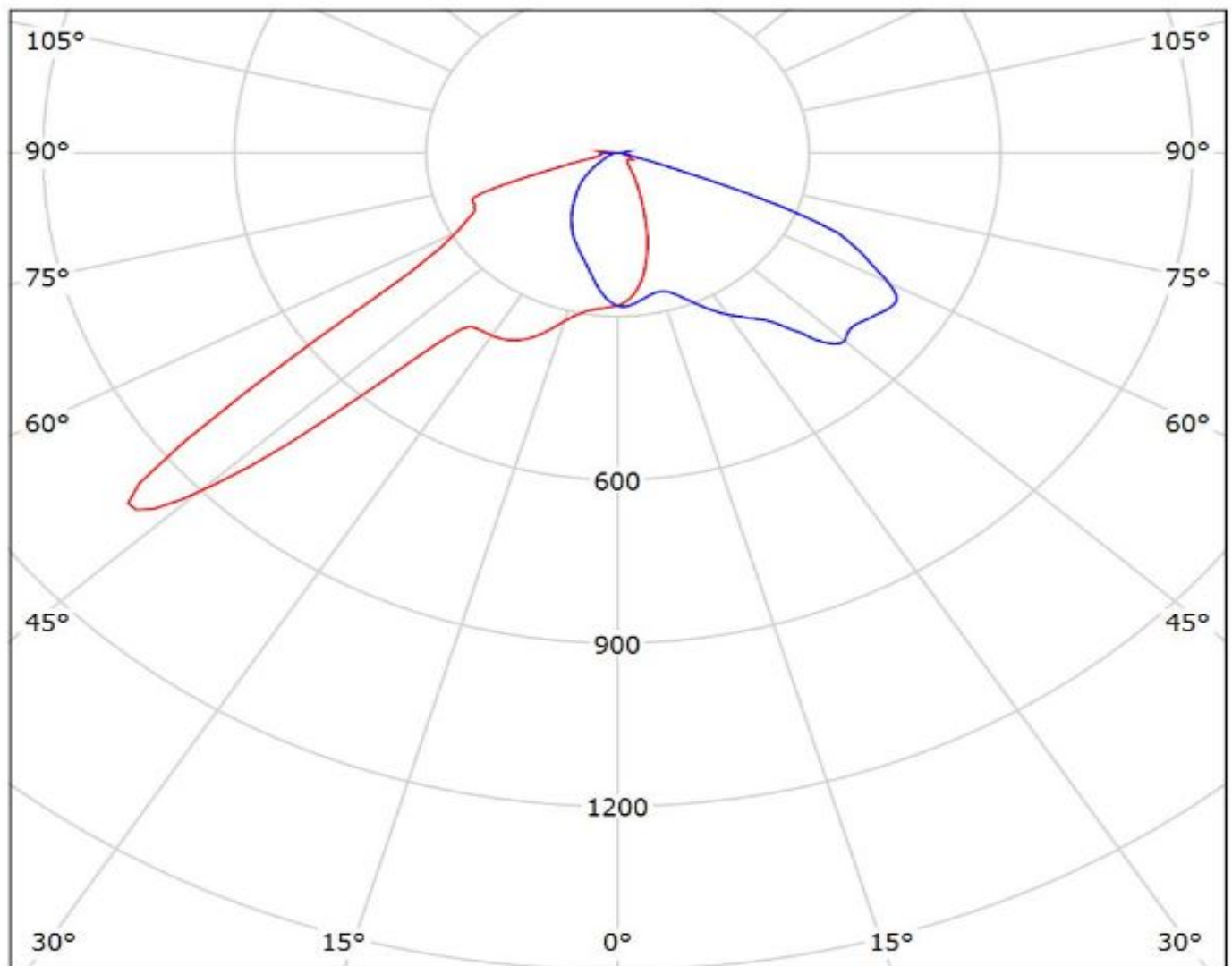

cd/klm

— C0 - C180 — C90 - C270

$\eta = 97\%$

Luminaire: Ledil Oy C14896_STRADA-2X2-PXL_(Oslon_Square_Gen3)_SIMULATED
Lamps: 1 x Osram Oslon Square Gen3 (GW CSSRM2.PC)

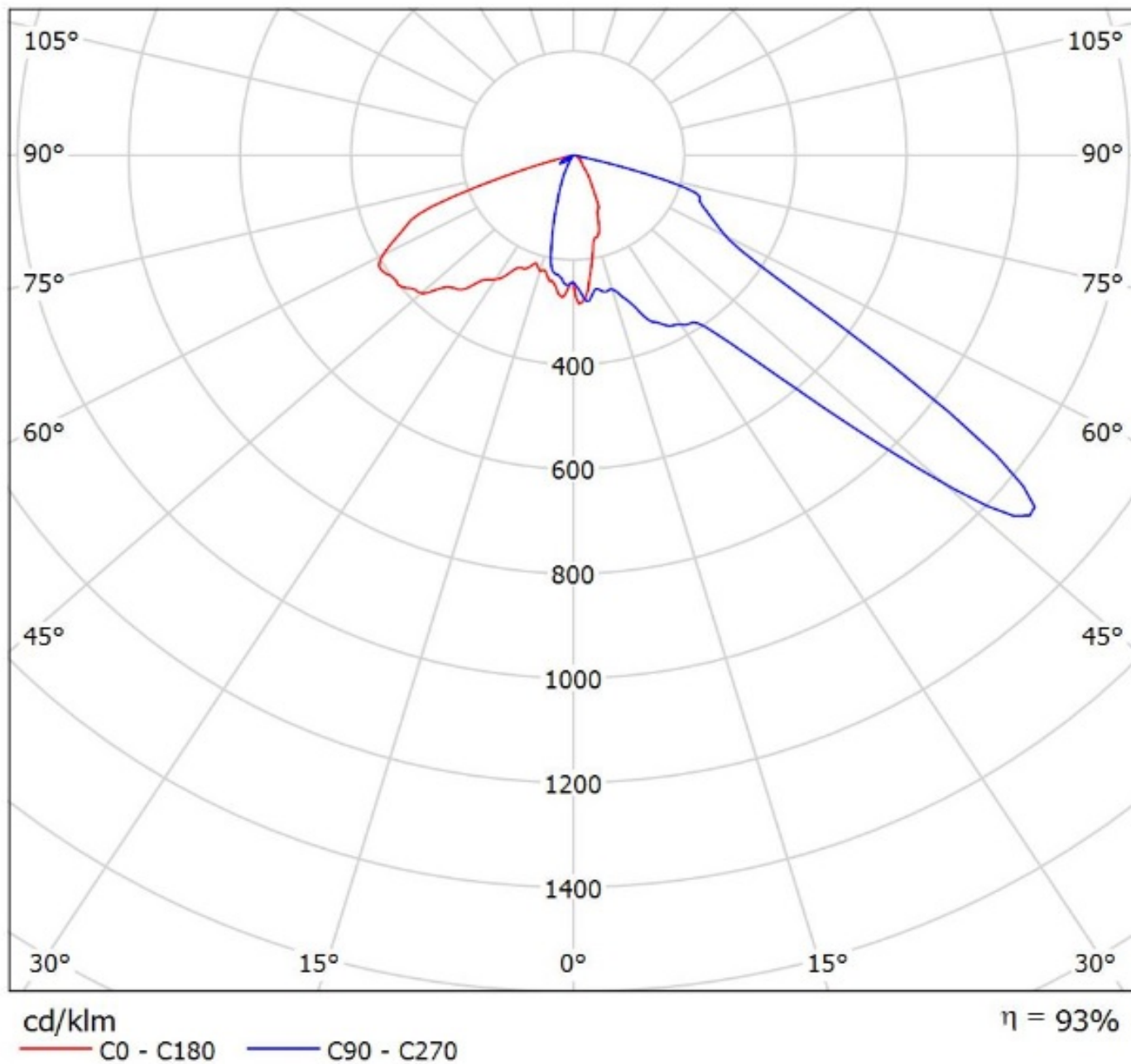

Luminaire: Ledil C14896_STRADA-2X2-PXL_(LH351B)

Lamps: 1 x Samsung_LH351B_2x2_444.178lm@250mA_P=2.8535W_I=0.25A

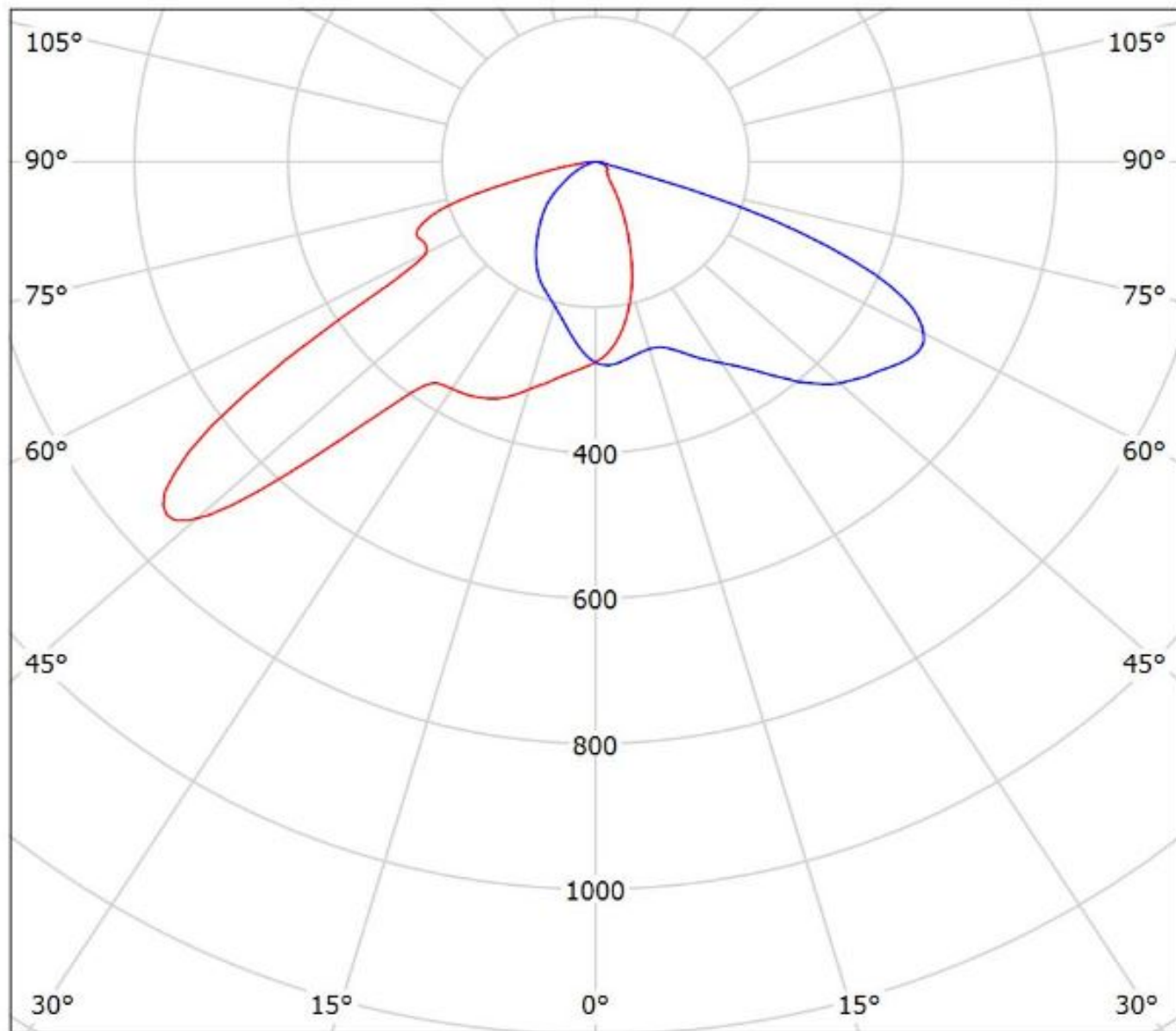

cd/klm

— C0 - C180

— C90 - C270

$\eta = 96\%$

NOTE: The typical divergence will be changed by different color, chip size and chip position tolerance. The typical total divergence is the full angle measured where the luminous intensity is half of the peak value.